

Aluminum GMAW Welding Guide

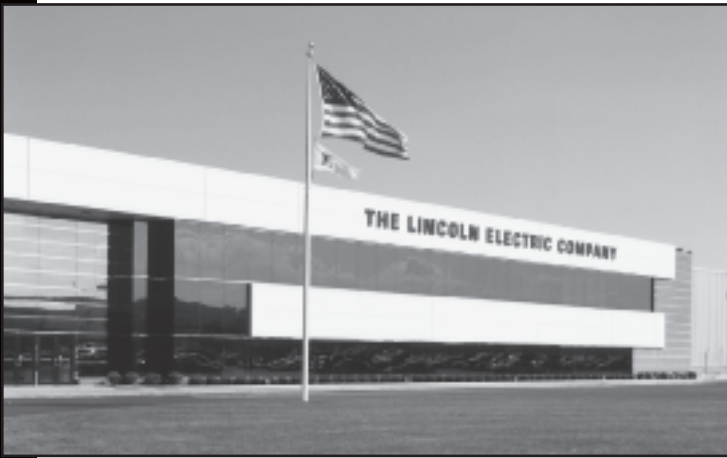

Gas Metal Arc Welding for Aluminum



About The Lincoln Electric Company®

Lincoln Electric® is the world's leading manufacturer of welding equipment and consumables. Our focus is on helping companies make their welding operations more effective, more efficient, more profitable.

We are dedicated to two equally important goals: exceptional quality and exceptional service. Our field support team — with hundreds of field sales engineers and thousands of knowledgeable and responsive Lincoln® distributors in countries all over the world — is the largest in the industry.

Innovative thinking.

A quality, service-first attitude.

Fresh approaches to design, manufacturing, and packaging.

Worldwide strength.

That's Lincoln Electric®.

Lincoln's Super Glaze® Technology

For superior welding performance, turn to Super Glaze® aluminum MIG wire from Lincoln Electric®. Super Glaze® prevents the problems usually associated with aluminum wire feeding such as birdnesting, tangling and burnback to provide a stable arc, great feedability and exceptional control — every time you weld! The keys are Super Glaze's smooth surface finish and consistent chemical composition. What this means for you is quality wire that produces a quality weld.

Let Us Put Our Experience to Work for You

As a major supplier of welding wire, Lincoln Electric® is the leader in MIG wire manufacturing technology. We carry that same technology and expertise to our aluminum MIG wire manufacturing. Our fully integrated aluminum MIG wire facility uses state-of-the-art equipment to produce a complete range of aluminum alloys including 1100, 4043 4047, 5183, 5356, 5554 and 5556.

What Makes Our Super Glaze® Stand Out From the Rest?

Three unique features:

1. A proprietary process which gives Super Glaze® a superior surface finish for optimum surface integrity.
2. A manufacturing process that precisely controls the alloy chemical composition to produce consistent physical characteristics.
3. State-of-the-art testing equipment to evaluate the surface condition and feedability of the wire to ensure problem-free welding.

What all this means to you is outstanding welding characteristics, spool to spool, time after time. Lincoln's aluminum MIG wire coupled with our advanced MIG welding equipment makes aluminum as easy to weld as any other material... and makes Lincoln® the one source for all your aluminum welding needs.

Important Information on our Website

Consumable AWS Certificates:

www.lincolnelectric.com/products/certificates/

Material Safety Data Sheets (MSDS):

www.lincolnelectric.com/products/msds/

ANSI Z49.1 Safety in Welding and Cutting and Arc Welding Safety Checklist:

www.lincolnelectric.com/community/safely/

Request E205 Safety Booklet:

www.lincolnelectric.com/pdfs/products/literature/e205.pdf

Here's How Our Process Works:

Controlling Alloys

The process of making aluminum MIG wires is a complex one, but one in which Lincoln® has a clear and distinct advantage. First, we utilize automated titling furnaces to efficiently produce the proper aluminum alloys. With this equipment, we are able to hold tight tolerances in the composition. The alloy is carefully refined prior to casting to minimize hydrogen, alkaline metals, and inclusions.

Continuous Casting

Second, we use a continuous casting process specially configured to high alloy materials. This process keeps the surface free from imperfections and impurities.

Drawing the Wire

In the last manufacturing step of the process, we use advanced wire drawing technology to preserve both surface integrity and internal soundness.

Testing the Wire

To ensure superior quality of welding wire, continuous finished product inspection is done. Surface quality is evaluated along with feedability and welding performance. This guarantees every spool of wire is problem-free.

Welding Performance

Most aluminum MIG welding problems are caused by poor feeding. Since aluminum is relatively soft, it is important that the wire surface be as smooth as possible for best feedability. Super Glaze® products provide easier feeding than competitive products because they have fewer surface imperfections as shown at the right. Super Glaze® wire also feeds with less force than typical competitive products as the feedability test graph shows. What this means is better control of the weld puddle for the operator. It also means longer gun liner and contact tip life as burnbacks do not occur.

With our MIG welding process knowledge, we understand that welding performance is one of the most important criteria used when selecting a wire. Aluminum MIG wire tends to produce a welding arc that is less stable than other materials because aluminum conducts electricity better. Small changes in wire diameter, wire feed speed, and current produce dramatic changes in weld bead profile, arc length and can even cause equipment downtime due to wire burnback and fusing to tip. Our continuous evaluation of finished product ensures consistency in manufacturing. You can count on Lincoln® aluminum MIG wire for superior arc stability, weld appearance, integrity and productivity.

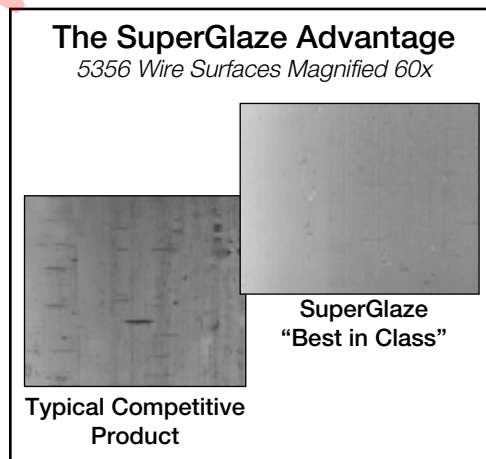
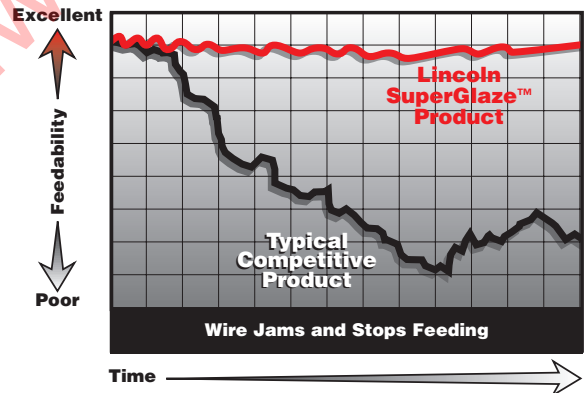

Effects of Alloying Elements	5-9
Introduction	5
Welding Aluminum vs. Welding Steel	5
Metallurgy	5-7
Aluminum Alloys	6
Wrought Alloys	6
Cast Alloys	6
Alloying Elements	6-7
Temper Designations	7-8
Effects of Welding on Aluminum Alloys	9
Nonheat-treatable Alloys	9
Heat-treatable Alloys	9
Filler Metal Selection	10-12
Aluminum Filler Alloys	10-11
Aluminum Filler Metal Guide	12
Welding Preparation	13-14
Storage and Handling of Aluminum Prior to Welding	13
Forming the Weld Preparation	13
Pre-weld Cleaning	13-14
GMAW of Aluminum Alloys	15-18
Properties of Aluminum	15
Modes of Metal Transfer	15
GMAW Power Supplies	15-16
GMAW-P Power Supplies	16
Wire Drives and Controls	16-17
Push and Push-Pull Type Feeders	16-17
Push-Pull GMAW Torches and Spool Guns	17
Aluminum Feeding Enhancement	17
Shielding Gas	18
Welding Techniques	18
Welding Defects — Causes and Cures	19-20
Solving Problems in Qualifying Weld Procedures	21
Meeting Tensile Test Requirements	21-22
Meeting Bend Test Requirements	21-22
General Welding Guidelines	23-26
Typical Melting Rates	23
Current vs. Wire Feed Speed	23
Welding Joint Design for Groove Welding	24-25
Welding Guidelines for Fillet and Lap Welding	26
Safety Practices	27-30

Effects of Alloying Elements

Introduction

The use of aluminum as a structural material is fairly recent. In fact, when the Washington Monument was completed in December, 1884, it was capped with a 100-ounce pyramid of pure aluminum, because aluminum was considered to be a precious metal at that time. The problem that impeded the use of aluminum is that it is a reactive metal. It is never found in its elemental state in nature, but is always tightly bound with oxygen as aluminum oxide, Al_2O_3 . Although aluminum oxide, found as bauxite ore, is plentiful, no direct reduction method, such as they used to make steel, has ever been found to produce aluminum from bauxite.

It was only after the American Charles M. Hall and the Frenchman Paul Heroult almost simultaneously, but independently, discovered electrolytic processes for obtaining pure aluminum from aluminum oxide (in 1886) that aluminum became available in commercial quantities. These processes, with some modifications, are still used today. In large part, it is the extremely large amount of electrical power required to produce aluminum that accounts for its higher cost relative to steel.

Since that time, aluminum has found wide use in numerous applications:

- It conducts electricity and heat almost as well as copper.
- It is widely used in electrical bus bars and other conductors, heat exchangers of all kinds, and cookware.
- It does not become brittle with decreasing temperature, but does become stronger, so it has found wide application in cryogenic equipment at temperatures as low as $-452^{\circ}F$ ($-269^{\circ}C$).
- It is very corrosion resistant in most environments, so it has found wide applications in marine and chemical environments.

The characteristics of aluminum alloys which make them attractive as structural materials are their light weight (one third the weight of steel for equal volumes) and their relatively high strength (equal in many cases to that of construction steel grades). This combination has resulted in increased use of aluminum alloys in applications such as passenger automobiles, trucks, over-the-road trailers, and railroad cars. Additionally, the structure of most aircraft is fabricated mainly from aluminum alloys, although in these applications, pieces are most often joined by riveting.

Welding Aluminum vs. Welding Steel

Most welders start out by learning how to weld steel. Some later move over to welding aluminum. Most welding equipment is designed to weld steel, with welding of aluminum alloys often being an afterthought, although this is changing. Very often we approach welding of aluminum as if it was just shiny steel. However, there are differences between steel and aluminum that usually make this approach doomed to failure.

The balance of this guide will discuss these differences and how to overcome them. They can all be summed up in three statements:

- 1. If you take enough care almost all steels are weldable. There are some aluminum alloys that just are not arc weldable.**

Fabricators fall into this trap regularly. We'll discuss the weldability of the various alloy families in detail. At this point, let's just say that many aluminum alloys, and especially the stronger ones, are not weldable.

- 2. All steels are heat-treatable. Some aluminum alloys are heat-treatable, but some are not.**

Even for the heat-treatable aluminum alloys, the heat treatments are totally different from those used for steel. In fact, if you heat up some alloys and quench them, they will become softer, not harder. Be aware of the differences and act accordingly.

- 3. When welding steels, you can almost always make a weld that is as strong as the parent material. In aluminum alloys, the weld will rarely be as strong as the parent material.**

This is usually true for welds in both heat treatable and nonheat-treatable alloys. The strength difference between the weld or heat affected zone (HAZ) and the parent material is often significant, often 30% or more.

Metallurgy

To understand aluminum, we must first understand some basics about aluminum metallurgy. Aluminum can be alloyed with a number of different elements, both primary and secondary, to provide improved strength, corrosion resistance, and general weldability.

The primary elements that alloy with aluminum are copper, silicon, manganese, magnesium and zinc. It is important to note that aluminum alloys fall into two classes: heat-treatable or nonheat-treatable.

Heat-treatable alloys are those that are heat-treated to increase their mechanical properties. To heat treat an alloy means heating it at a high temperature, putting the alloying elements into solid solution and then cooling it at a rate which will produce a super saturated solution. The next step in the process is to maintain it at a lower temperature long enough to allow a controlled amount of precipitation of the alloying elements.

With the nonheat-treatable alloys it is possible to increase strength only through cold working or strain hardening. To do this, a mechanical deformation must occur in the metal structure, resulting in increased resistance to strain, producing higher strength and lower ductility.

Aluminum Alloys

Much in the same manner that the American Iron and Steel Institute (AISI) registers steel chemistries and grades, the Aluminum Association (AA) registers alloy designations, chemistries, and mechanical properties for aluminum alloys. However, the alloy designation system is totally different than that used for steels. Additionally, different designation systems are used for **wrought** and **cast** alloys.

Wrought Alloys

Wrought alloy designations use a four digit number, plus a temper designation, discussed later. Aluminum alloys are broken up into eight "families" depending on the main alloying elements. The aluminum alloy families are shown in Table 1, along with their heat treatability.

Table 1: Wrought Alloy Destinations

Alloy Family	Main Alloying Elements	Heat Treatable
1XXX	Pure Aluminum	No
2XXX	Copper (sometimes with magnesium)	Yes
3XXX	Manganese (sometimes with magnesium)	No
4XXX	Silicon	No
5XXX	Magnesium	No
6XXX	Magnesium plus silicon	Yes
7XXX	Zinc (sometimes with magnesium and copper)	Yes
8XXX	All others	Normally Yes

NOTE: The designation 2XXX, etc. is an industry standard abbreviation used to mean "all the alloys in the 2000 series".

For example, if you have a piece of 6061, it's clear that it is a wrought alloy (4 digits), it's heat treatable, and it contains magnesium and silicon. The second digit of the four shows whether the alloy is the first such alloy registered, in which case the second digit will be "0", as in 5054. Digits other than "0" indicate that the alloy is a modification of a registered alloy. 5154 would be the first modification of 5054. Alloy 5754 is the seventh modification. The last two digits are assigned arbitrarily by the Aluminum Association when the alloy is registered. Note there is no indication of alloy or weld strength given by the material designation.

Cast Alloys

The designation system for cast alloys are classified into families as shown in Table 2. The specific families are somewhat different from the designations for wrought alloys and the designations have only three digits followed by a decimal point and one more digit. For these alloys, the first digit shows the alloy family. The next two digits are arbitrarily assigned. Alloy modifications are shown by a letter prefix, so 356 is the original version of an alloy and A356 is the first modification, B356 is the second modification, etc. The number following the decimal point designates whether the alloy is produced as a casting of final form or is produced as an ingot for re-melting.

Table 2 — Cast Alloy Destinations

Alloy Family	Main Alloying Elements	Heat Treatable
1XX.X	Pure Aluminum	No
2XX.X	Copper	Yes
3XX.X	Silicon plus magnesium	Yes
4XX.X	Silicon	Yes
5XX.X	Magnesium	No
6XX.X	Not Used	NA
7XX.X	Zinc	Yes
8XX.X	Tin	No
9XX.X	Other	

Alloying Elements

Pure Aluminum (1XXX series) Contains no alloying elements, and is not heat-treatable. It is used primarily in chemical tanks and pipe because of its superior corrosion resistance. This series is also used in electrical bus conductors because of its excellent electrical conductivity. It is welded easily with 1100 and 4043 filler wires.

Copper (2XXX series) Provides high strength to aluminum. This series is heat-treatable and mainly used in aircraft parts, rivets and screw products. Most 2XXX series alloys are considered poor for arc welding because of their sensitivity to hot cracking. Most of these alloys should not be welded, however, alloys 2014, 2219 and 2519 are easily welded with 4043 or 2319 filler wire. These three alloys are widely used in welded fabrication.

Manganese (3XXX series) Yields a nonheat-treatable series used for general-purpose fabrication and build-up. Moderate in strength, the 3XXX series is used for forming applications including utility and van trailer sheet. It is improved through strain hardening to provide good ductility and improved corrosion properties. Typically welded with 4043 or 5356 filler wire, the 3XXX series is excellent for welding and not prone to hot cracking. Its moderate strengths prevent this series from being used in structural applications.

Silicon (4XXX series) Silicon reduces the melting point of the aluminum and improves fluidity. Its principle use is as filler metal. The 4XXX series has good weldability and is considered a nonheat-treatable alloy. Alloy 4047 is often used in the automotive industry as it is very fluid and good for brazing and welding.

Magnesium (5XXX series) When added to aluminum, magnesium has excellent weldability, good structural strength and is not prone to hot cracking. In fact, the 5XXX series has the highest strength of the nonheat-treatable aluminum alloys. It is used for chemical storage tanks and pressure vessels as well as structural applications, railway cars, dump trucks and bridges because of its corrosion resistance.

Silicon and Magnesium (6XXX series) This medium strength, heat-treatable series, is primarily used in automotive, pipe, railings, and structural extrusion applications. The 6XXX series is prone to hot cracking, but this problem can be overcome by the correct choice of joint and filler metal. Can be welded with either 5XXX or 4XXX series without cracking — adequate dilution of the base alloys with selected filler wire is essential. A 4043 filler wire is the most common for use with this series. 6XXX alloys should never be welded autogenously, they will crack.

Zinc (7XXX series) Zinc added to aluminum with magnesium and copper produces the highest strength heat-treatable aluminum alloy. It is primarily used in the aircraft industry. The weldability of the 7XXX series is compromised in higher copper grades, as many of these grades are crack sensitive (due to wide melting ranges and low solidus melting temperatures). Grades 7005 and 7039 are weldable with 5XXX filler wires. They are widely used for bicycle frames and other extruded applications.

Other (8XXX series) Other elements that are alloyed with aluminum (i.e. lithium) all fall under this series. Most of these alloys are not commonly welded, though they offer very good rigidity and are principally used in the aerospace industry. Filler wire selection for these heat-treatable alloys include the 4XXX series.

In addition to the primary aluminum alloying elements, there are a number of secondary elements, which include chromium, iron, zirconium, vanadium, bismuth, nickel and titanium. These elements combine with aluminum to provide improved corrosion resistance, increased strength and better heat treatability.

Temper Designations

The information above allows an aluminum alloy to be recognized by its chemistry, but not by the heat treatment or mechanical properties. To show these properties, temper designations are assigned. The complete designation of an alloy might be 6061-T6 or 5083-H114. Most of these designations are different for heat-treatable and nonheat-treatable alloys; however, two common designations apply to all alloys:

- **"O" Temper** (not zero). When an alloy is given this designation, the supplier has annealed the alloy, typically at 650-750°F (343-300°C), and it is as soft as possible.
- **"F" Temper**. When an alloy is supplied in this temper it is supplied "as fabricated". This means the supplier is guaranteeing that the chemistry of the material meets the chemical requirements for the specified alloy, but there are no claims regarding the mechanical properties of the alloy. This temper is often specified by fabricators who subsequently forge or form the supplied material and establish mechanical properties by heat treatment after forming.

To discuss the remainder of the temper designations, we need to discuss the heat-treatable and nonheat-treatable alloys.

Nonheat-Treatable Alloys — Strain-Hardened Designations

These alloys cannot be strengthened by heat treatment. However, they can be strengthened by **cold working**, also called **strain hardening**. If an aluminum alloy is deformed at elevated temperatures, [600°F (315°C) or higher], little or no strengthening

takes place. However, if the alloy is deformed at lower temperatures, it will gain strength. In general:

- The more the alloy is deformed, the stronger it gets. Finally, at some point, the alloy will have no ductility and will fracture.
- The higher the alloy content, the more it will gain strength by being deformed.

Both of these phenomena are shown in Figure 1.

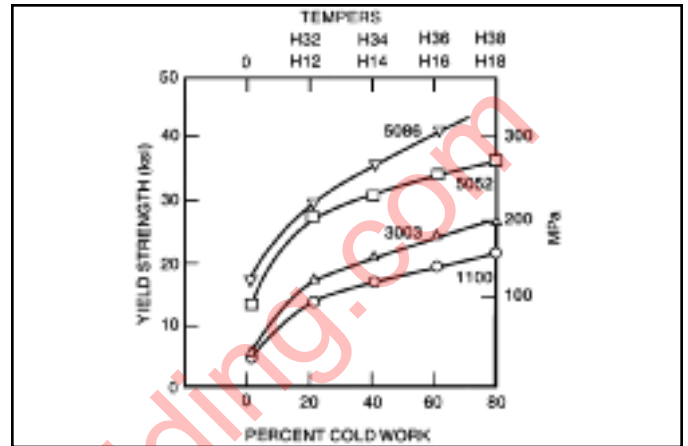

Figure 1: Relationship of Yield Strength, Amount of Cold Work and Alloy Content

The temper designation for strain hardened alloys is usually made up of two digits as shown in Table 3.

The first digit shows whether the alloy is only strained or whether it has been partially annealed and/or stabilized. The second digit shows how much strain hardening has been put into the alloy. Higher numerical values mean higher strain levels, which means higher yield and tensile strengths.

Table 3: "H" Temper Designations

First Digit Indicates Basic Operations	
H1	Strain Hardened Only
H2	Strain Hardened and Partially Annealed
H3	Strain Hardened and Stabilized
Second Digit Indicates Degree of Strain Hardening	
HX2	Quarter Hard
HX4	Half Hard
HX6	Three-Quarters Hard
HX8	Full Hard
HX9	Extra Hard

Heat Treatable Alloys

Strain hardened "H" tempers are not used for heat-treatable alloys. Instead a series of "T" tempers indicating the heat treatment state are used. A total of (10) tempers exist; "T1" through "T10". The commonly seen designations are "T4" and "T6". All 10 designations are listed in Table 4 on the following page.

Table 4 — T1 through T10 Temper Designations

T1	Cooled from an elevated temperature shaping process and naturally aged to a substantially stable condition. Applies to products that are not cold worked after cooling from an elevated temperature shaping process, or in which the effect of cold work in flattening or straightening may not be recognized in mechanical property limits.	T7	Solution heat-treated⁽¹⁾ and overaged/stabilized. Applies to wrought products that are artificially aged after solution heat treatment to carry them beyond a point of maximum strength to provide control of some significant characteristic ⁽²⁾ . Applies to cast products that are artificially aged after solution heat treatment, to provide dimensional and strength stability.
T2	Cooled from an elevated temperature shaping process, cold worked and naturally aged to a substantially stable condition. Applies to products that are cold worked to improve strength after cooling from an elevated temperature shaping process, or in which the effect of cold work in flattening or straightening is recognized in mechanical property limits.	T8	Solution heat-treated⁽¹⁾, cold worked, and then artificially aged. Applies to products that are cold worked to improve strength, or in which the effect of cold work in flattening or straightening is recognized in mechanical property limits.
T3	Solution heat-treated⁽¹⁾, cold worked and naturally aged to a substantially stable condition. Applies to products that are not cold worked to improve strength after solution heat treatment, or in which the effect of cold work in flattening or straightening is recognized in mechanical property limit.	T9	Solution heat-treated⁽¹⁾, artificially aged, and then cold worked. Applies to products that are cold worked to improve strength.
T4	Solution heat-treated⁽¹⁾ and naturally aged to a substantially stable condition. Applies to products that are cold worked after solution heat-treatment, or in which the effect of cold work in flattening or straightening may not be recognized in mechanical property limits.	T10	Cooled from an elevated temperature shaping process, cold worked, and then artificially aged. Applies to products that are cold worked to improve strength, or in which the effect of cold work in flattening or straightening is recognized in mechanical property limits.
T5	Cooled from an elevated temperature shaping process and then artificially aged. Applies to products that are not cold worked after cooling from an elevated temperature shaping process, or in which the effect of cold work in flattening or straightening may not be recognized in mechanical property limits.		
T6	Solution heat-treated⁽¹⁾ and then artificially aged. Applies to products that are not cold worked after solution heat-treatment, or in which the effect of cold work in flattening or straightening may not be recognized in mechanical property limits.		

⁽¹⁾ Solution heat treatment is achieved by heating cast or wrought products to a suitable temperature, holding at that temperature long enough to allow constituents to enter into solid solution and cooling rapidly enough to hold the constituents in solution. Some 6XXX series alloys attain the same specified mechanical properties whether furnace solution heat treated or cooled from an elevated temperature shaping process at a rate rapid enough to hold constituents in solution. In such cases, the temper designations T3, T4, T6, T7, T8 and T9 are used to apply to either process and are appropriate designations.

⁽²⁾ For this purpose, *characteristic* is something other than mechanical properties. The test method and limit used to evaluate material for this characteristic are specified at the time of the temper registration.

Aluminum alloys are heat treatable because of a phenomenon called **precipitation hardening**. They do not harden by a martensitic transformation as steel does. In precipitation hardening, one metal can be dissolved in another in a "solid solution" and solubility generally increases with temperature. For example, just as sugar will dissolve in a glass of iced tea when heated — copper, zinc or combinations of magnesium and silicon will dissolve in aluminum as it is heated.

When the heat-treatable alloys are heated to approximately 950°F (510°C), and held for a few minutes, all the alloying elements are taken into a solution in the solid aluminum. This is termed a "solution heat treatment". Normally, the alloy is quenched in water from this point to arrive at the T4 temper. Although the T4 temper is substantially stronger than the annealed "O" temper, the primary purpose of quenching is not strengthening. Instead, the quenching serves to keep the alloy additions in solution at room temperature — if the aluminum were cooled slowly from the solution treatment, the alloying additions would re-precipitate and no strengthening would occur.

The tensile and yield strengths of the material will increase for several weeks after the heat treatment and, in some alloys, can increase significantly. However, once past this initial period, the alloy is stable indefinitely. The user normally is unaware of this initial strength increase because the aluminum producer doesn't ship the alloy until the strength has stabilized.

The T4 temper, while stable, does not give maximum strength to the alloy. Most alloys are sold in a maximum strength T6 temper. To get from T4 to T6 temper, the material is put in a furnace at a temperature of 325°F to 400°F (163°C to 204°C) and allowed to age 1 to 5 hours. The dissolved alloying elements will form submicroscopic pre-precipitates in the material and produce maximum strength. If this aging heat treatment is carried out at too high a temperature or for too long, the precipitates will get too large and a lower strength "overaged" condition will result.

Note: This final aging heat treatment is carried out at 400°F (204°C) maximum. The welding heat, which can heat the surrounding material to well over this temperature, can significantly degrade the strength of the weld heat affected zone (HAZ), which is discussed in more detail on the following page.

Effects of Welding on Mechanical Properties of Aluminum Alloys

As before, it is easiest to discuss the effects of welding on the mechanical properties of aluminum weldments if we discuss nonheat-treatable alloys and heat-treatable alloys separately.

Nonheat-Treatable Alloys

As was discussed earlier, these alloys can be, and often are, strengthened by cold working. Cold worked alloys can have yield and tensile strengths twice those of the annealed "O" temper alloy. These cold worked alloys can be softened back to the "O" temper by annealing at 650-700°F (343-371°C). Since the heat of welding produces temperatures considerably higher than this at the weld fusion line, the result of welding is that the heat affected zone (HAZ) of welds in nonheat-treatable alloys (ie, 1XXX, 3XXX, 4XXX, and 5XXX alloys) becomes annealed.

Therefore, the strength of the weld joint is always equal to the strength of the "O" temper annealed base material, regardless of what the starting temper of the parent material was. If you weld "O" temper material, the weld will be as strong as the starting parent material. If you weld any material that is strain hardened (ie, cold worked), the weld will be weaker than the starting material, perhaps significantly weaker.

The HAZ can never become softer than the "O" temper, so that excess welding heat input will not make the HAZ softer. It can, however, make the HAZ wider. Normally, this will not further reduce the strength of the welded joint, although other problems can arise due to excessive heat input.

From a practical standpoint, there is no way to regain the strength lost during welding. If the weld is cold worked, it will begin to work harden again. However, this is not usually a practical industrial solution, because, in most cases, the weld will not be as strong as the starting cold worked material.

Heat-Treatable Alloys

There is no blanket statement that can be made about the welded strength of heat-treatable alloys. As previously stated, the weld will generally be weaker than the parent material. However, the welded properties will strongly depend on the temper of the material before welding and also on heat treatments performed after welding. Figure 2 shows a micro-hardness trace across a weld, starting at the center of the weld. The graph actually shows four curves representing what happens to material in the T4 and T6 tempers in the as-welded (AW) and postweld heat-treated (PWA) conditions. The following can be noted:

1) The HAZ is about 1/2" (12.7 mm) wide. The actual width of the HAZ will depend on a number of things, including the welding process used and the thickness of the material. HAZ widths of 1" (25.4 mm) are not uncommon in thin materials.

2) The hardness and strength of the weldment is typically lowest in the HAZ. Because of this, strength of the welding filler alloy is not a primary concern when making butt welds. A weld will most often fail in the HAZ.

3) Unlike nonheat-treatable alloys, the hardness (and therefore strength) in the HAZ is not always the same. It depends on the

material temper prior to welding and whether the weld is post-weld aged.

- The weakest HAZ occurs when the material is welded in the T6 temper and used as-welded.
- The HAZ, and therefore the weldment, will actually be slightly stronger if the material is used in the T4 temper and used as-welded.
- If the weldment in either T4 or T6 material is post-weld aged, the strength of the HAZ can increase significantly. The exact postweld heat treatment varies with the alloy, but is usually an aging at around 400°F (204°C) for about one hour.

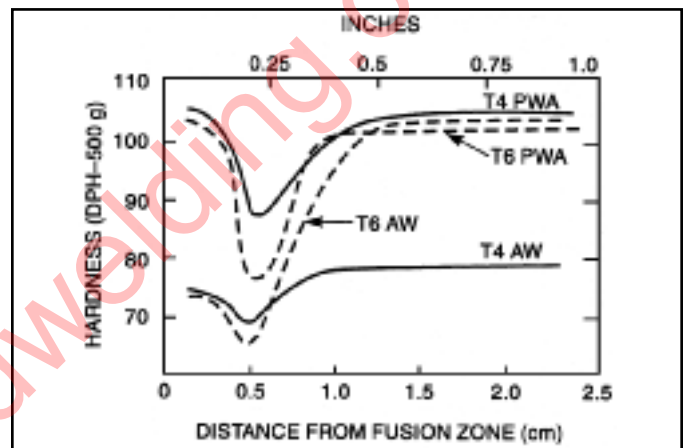

Figure 2: Hardness vs. Distance for 6061-T4 and -T6 in the as-welded and post-weld aged conditions.

The fabricator has some options that he doesn't have when fabricating the nonheat-treatable alloys in terms of recovering some of the strength lost during welding. For instance, since the 6XXX alloys also bend easier and around a smaller radius in the T4 temper than in the T6 temper, these alloys can be bought in the T4 temper, formed easily, welded, and then aged. The resulting mechanical properties will be significantly higher than if the material was purchased in the T6 temper.

Finally, if the right filler alloy is chosen, the finished weldment can be completely heat-treated and the T6 properties restored. This requires a re-solution heat treatment, quench, and re-aging. This is often practical for small structures, but not for large ones. For example, aluminum bicycle frames are often fabricated in this way.

The HAZ of welds in heat-treatable alloys is significantly different than those in nonheat-treatable alloys. The strength of the HAZ in heat-treatable alloys can be made considerably wider and weaker if excessive heat input is used. Therefore, it is very important not to use excessive preheats [200°F (93°C) maximum is recommended], to carefully monitor interpass temperatures [250°F (121°C) maximum is recommended], and to avoid practices such as wide weave passes which will result in excessive heat input.

Filler Metal Selection

Aluminum Filler Alloys

Most common aluminum filler alloys fall into the 4XXX and 5XXX families, with a few coming from the 1XXX, 2XXX, and the casting alloys. The chemical composition of the common aluminum filler alloys is shown in Table 5, below.

There are a number of characteristics which determine the best filler metal choice for a given base material, or combination of base materials. Among these are:

- Freedom from hot cracking.
- Weld metal ductility.
- Weld metal corrosion resistance.
- Weld metal shear strength in fillet and lap joints.
- Ease of welding (i.e., weldability).
- Filler wire feedability.
- Weld color match with parent metal for applications requiring postweld anodizing.

There are a number of filler metal selection charts which have taken these factors into account and give good overall recommendations for filler metal selection. A composite of these charts covering most alloy combinations are shown in Table 7 on page 12.

In general, filler alloy recommendations for the various alloy families can be summarized as follows:

1XXX alloys — These alloys are usually used for their electrical conductivity and/or corrosion resistance. Their sensitivity to hot cracking is very low. They are usually welded using 1100 or 1188 fillers, but matching filler metals are also available for specialized alloys such as 1350. If electrical conductivity of the joint is not of primary importance, 4043 may be used.

2XXX alloys — Many alloys in this series are not arc weldable. Those that are include 2219, 2014, 2519, 2008, and 2036. Alloy 2319 is a matching filler alloy for 2219 and 2519 and can also be used on the other weldable alloys. Alloys 4043 and 4145, which contain copper, can also be used. Alloy 5XXX fillers should not be used to weld 2XXX parent materials, because cracking will result.

3XXX alloys — These moderate strength aluminum-manganese alloys are relatively crack resistant and can be welded easily using either 4043 or 5356.

4XXX alloys — These alloys are usually found as welding or brazing fillers. In the rare event they are encountered as parent materials, 4047 is usually the best choice as a filler metal.

Table 5

WIRE CHEMICAL COMPOSITION FOR COMMON ALUMINUM WIRES

AWS A5.10-99 ASME SFA-5.10 Classification	%Mn	%Si	%Fe	%Mg	%Cr	%Cu	%Ti	%Zn	%Be	%Others ⁽¹⁾	%Al
ER1100 & Alloy 1050	0.05	—	—	—	—	0.05-0.20	—	0.10		0.05	99.0
ER2319	0.20-0.40	0.20	0.30	0.02	—	5.8-6.8	0.10-0.20	0.10	(2)	0.05 ⁽³⁾	Balance
ER4043	0.05	4.5-6.0	0.8	0.05	—	0.30	0.20	0.10	(2)	0.05	Balance
ER4047	0.15	11.0-13.0	0.8	0.10	—	0.30	—	0.20	(2)	0.05	Balance
Alloy 5052	0.10	0.25	0.40	2.2-2.8	0.15-0.35	0.10	—	0.10	(2)	0.05	Balance
Alloy 5056	0.05-0.20	0.30	0.40	4.5-5.6	0.05-0.20	0.10	—	0.10	(2)	0.05	Balance
Alloy 5154	0.10	0.25	0.40	3.1-3.9	0.15-0.35	0.10	0.20	0.20	(2)	0.05	Balance
ER5183	0.50-1.0	0.40	0.40	4.3-5.2	0.05-0.25	0.10	0.15	0.25	(2)	0.05	Balance
ER5356	0.05-0.20	0.25	0.40	4.5-5.5	0.05-0.20	0.10	0.06-0.20	0.10	(2)	0.05	Balance
ER5554	0.50-1.0	0.25	0.40	2.4-3.0	0.05-0.20	0.10	0.05-0.20	0.25	(2)	0.05	Balance
ER5556	0.50-1.0	0.25	0.40	4.7-5.5	0.05-0.20	0.10	0.05-0.20	0.25	(2)	0.05	Balance
ER5654	0.01	—	—	3.1-3.9	0.15-0.35	0.05	0.05-0.15	0.20	(2)	0.05	Balance

NOTE: Single values are maximum, except aluminum.

(1) Total of "others" shall not exceed 0.15%.

(2) Beryllium shall not exceed 0.0003%.

(3) Vanadium content shall be 0.05 - 0.15% and Zirconium content shall be 0.10 - 0.25%.

5XXX alloys — These higher strength aluminum–magnesium alloys are the most common structural aluminum sheet and plate alloys. The general rule, except for the alloy 5052, is to choose a 5XXX filler metal with slightly higher magnesium content than the parent material being welded. For all alloys except 5052, 5XXX alloys should not be welded using 4XXX filler alloys. The high Mg content of the parent material, when combined with the high Si content of the 4XXX fillers, will result in a high level of Mg₂Si — a brittle intermetallic compound which will cause the weld to have poor ductility and toughness. In choosing filler alloys for 5XXX alloys, there are several specific recommendations as follows:

5052 — This alloy has just the right amount of Mg content to exhibit a relatively high crack sensitivity. If it is welded with 5052 filler alloy, it will often crack. To avoid the tendency to crack, 5052 is usually welded with a filler alloy of much higher Mg content, such as 5356. The resulting weld metal, which is an alloy of the 5356 and 5052, has a Mg content high enough to be crack resistant. Additionally, the Mg content of 5052 is low enough so that it can be successfully welded using 4043.

High temperature applications — Al-Mg alloys with Mg content over 3% are unsuitable for service temperatures over 150°F (65°C) because they are susceptible to stress corrosion cracking at higher temperatures. This is true for filler alloys as well and should be taken into account in selecting filler alloys

5454 — This alloy is a lower Mg alloy specifically developed to be immune to the stress corrosion cracking noted above. Filler alloy 5554 is designed as a matching filler alloy for 5454 and should be used whenever possible.

5083 and 5456 — These high Mg, high strength alloys can be successfully welded using 5356. However, most structural Codes require that welds in these alloys have a minimum ultimate tensile strength of 40 ksi (276 MPa). When welded using 5356, welds in these alloys often will not meet this requirement. For this reason, 5183 or 5556 are recommended for these alloys.

6XXX alloys — These Al-Mg-Si alloys are primarily used for extrusion alloys, although they can also often be found as sheet and plate. The chemistry of these alloys makes them very sensitive to hot short cracking. Autogenous welds (i.e., welds made without adding filler metal) will almost always crack. This is why

6061 filler metal does not exist. If it did, welds made using it would crack. Yet, these alloys are readily weldable using either 4043 or 5356 filler metal. Since the chemistry of 4043, Al with 5% Si, or 5356, Al with 5% Mg, is so different than that of 6061, when either is mixed with 6061, the result is a weld with a crack resistant chemistry.

The decision whether to use 4043 or 5356 depends on a number of factors summarized in Table 6. This table compares these two common filler metals and shows the advantages and disadvantages of each.

As shown in Table 6, 4043 is easier for the welder to use, it flows better, and is more crack resistant. Filler metal 5356 feeds better and gives welds that are stronger, especially in lap welds and fillet welds, and are more ductile. While 5356 should be used to weld the 6XXX alloys to any of the 5XXX alloys, 4043 should be used to weld the 6XXX alloys to the common 3XX.X casting alloys.

Table 6 — Comparison of Filler Metals 4043 and 5356

ER4043	ER5356
Smooth Bead, Good Wetting	Black Smut, Distinct Ripples
Low Column Strength	Best Feedability
Higher Penetration	Lower Penetration
Lower Ductility	Higher Ductility
Lower Tensile	Higher Tensile
Less Prone to Porosity	More Prone to Porosity
Anodizes a Dark Grey	Anodizes with Good Color Match
Much Lower Shear Strength	Higher Shear Strength
Lower Cracking Sensitivity	Higher Cracking Sensitivity
Lower Melting Point	Higher Melting Point
Narrower Melting Range	Wider Melting Range

Note: 5356 should be used for applications that will be subsequently anodized. 5356 will anodize to a color very similar to the parent material. 4043 will turn dark grey on anodizing. Since the 6XXX parent materials anodize to a clear color, a 4043 weld is very visible and not desirable.

7XXX alloys — Although most of these alloys are not arc-weldable, 7005, 7003, and 7039, display good weldability. These alloys should be welded using 5356.

ALUMINUM PRODUCT SELECTION GUIDE

AWS Classification	Aluminum	
		Lincoln Product Name
ER1100		Super Glaze® 1100
ER4043		Super Glaze 4043
ER4047		Super Glaze 4047
ER5183		Super Glaze 5183
ER5356		Super Glaze 5356
ER5554		Super Glaze 5554
ER5556		Super Glaze 5556

Request publication C8.05 for more information on Lincoln's Super Glaze® premium aluminum GMAW wires.



Super Glaze® Aluminum GMAW Wire

Table 7: Aluminum Alloy Filler Metals for Structural Welding of Various Base Aluminum Alloys

Base Metal to Base Metal	1060, 1100, 3003, Alclad 3003	2219, A201.0	3004, Alclad 3004	5005, 5050	5052, 5652	5083, 5456	5086, 514.0, 535.0	5154, 5254	5454	6005, 6061, Alclad 6061, 6063, 6351	7005	354.0, C355.0	356.0, A356.0, 357.0, A357.0, 359.0, 443.0 A444.0
356.0, A356.0, 357.0, A357.0, 359.0, 443.0, A444.0	4043	4145	4043	4043	4043	5356	5356	4043	4043	4043	4043	4145	4043
354.0, C355.0	4145	4145	4145	4145	4043	NR	NR	NR	4043	4145	4145	4145	
7005	5356	4145	5356	5356	5356	5556	5356	5356	5356	5356	5356		
6005, 6061, Alclad 6061, 6063, 6351	4043	4145	5356	4043, 5356	5356, 4043	5356	5356	5356	5356	4043, 5356			
5454	4043	4043	5356	5356	5356	5356	5356	5356	5554				
5154, 5254	4043	NR	5356	5356	5356	5356	5356	5356					
5086, 514.0, 535.0	5356	NR	5356	5356	5356	5356	5356						
5083, 5456	5356	NR	5356	5356	5356	5556, 5183							
5052, 5653	4043	4043	4043	4043, 5356	5356								
5005, 5050	4043	4145	4043	4043, 5356									
3004, Alclad 3004	4043	4145	4043										
2219, A201.0	4145	2319											
1060, 1100, 3003, Alclad 3003	1100												

Notes:

- 1) The filler alloy shown is the best choice for most structural applications. Where two filler alloys are shown, either are acceptable.
- 2) Whenever 4043 filler alloy is shown, 4047 is an acceptable alternate.
- 3) Whenever 5356 filler alloy is shown, 5556 or 5183 are acceptable alternates.
- 4) Al-Mg alloys containing more than 3% Mg should not be used in applications where long term exposures above 150°F (65°C) are encountered.
- 5) There are applications where specific requirements make the selection of filler alloys other than those shown above necessary.

Welding Preparation

Preparation for welding includes storage and handling of aluminum prior to welding, methods for making the weld preparation, and methods for cleaning prior to welding. While not strictly "welding preparation", methods for backgouging and interpass cleaning will be included in this section.

Storage of Aluminum and Aluminum Wire Prior to Welding

Improper storage of aluminum and aluminum wire prior to welding makes preparation for welding much more costly at best. At worst, it can result in welds of inadequate quality.

It is well known that all aluminum alloys form a thin oxide coating immediately upon exposure to air. This coating is extremely thin, approximately 100–150 Angstroms (one millionth of a centimeter) thick. Because it is so thin, it is transparent and not visible to the naked eye. When stored at ambient temperatures and relative humidity levels of 70% or below, the oxide thickness increases extremely slowly. It is safe to say that aluminum and aluminum wires stored under these conditions will be usable for a couple of years. Plus, the reverse polarity arc tends to strip off the oxides. Therefore, if aluminum is stored in a dry area, oxide removal prior to welding will be very easy or unnecessary.

However, if aluminum is subjected to temperatures above 200°F (93°C) and/or very high humidity levels, the oxide layer thickness can grow rapidly. Because of this, the following guidelines are suggested:

- Aluminum plate which has ever become wet should be scrapped. Boxes of wire where the cardboard box has become wet on the inside should be discarded.
- Aluminum should never be stored outside.
- Wire should be stored in the original box and any plastic interior bag it came in.
- It is helpful to store wire in a closed cabinet which is heated to approximately 20°F (-6°C) above the ambient temperature to reduce relative humidity. This can be done simply by mounting an electrical fixture with a low wattage bulb inside the cabinet and letting the bulb burn continuously.
- Wire which will not be used for 2 days or more should be dismantled from the wire feeder, returned to its original packaging, and stored properly.

Aluminum wire which is stored in accordance with the above recommendations will be usable with no deterioration in performance for at least 2 years. Wire older than this should be discarded.

Oxides on aluminum plate can be removed by power wire brushing, sanding, grinding, or chemical etching, however, proper storage will prevent the formation of oxides. Aluminum should be stored indoors in a dry environment. If stored outside, it should be securely covered to keep it dry. Under no circumstances should it be stored uncovered with one plate laying flat

on top of another. This will allow water to "wick" in between the plates from the edges. If this happens, thick hydrated oxide will form very quickly on the plate surfaces, making it very difficult to pry the two plates apart.

Welding Preparation

Even the hardest aluminum alloy is much softer than a high speed steel or carbide cutting tool. While specialized tools are available to cut aluminum, aluminum is easily cut using circular saws, radial arm saws, etc. End preparations can be put on pipe or tube using woodworking routers. The general rule is "if it will cut wood, it will cut aluminum".

While aluminum can't be cut using oxyfuel cutting equipment, it can be easily cut using plasma cutting equipment. Thin aluminum, less than 3/16" (4.8 mm) thick, can also be cut by high powered lasers. However, care must be taken in plasma or laser cutting of heat-treatable alloys. These alloys are prone to form micro-cracks which can extend back from the cut edge as far as 1/8" (3.2 mm). Therefore, laser or plasma cut edges in heat-treatable alloys are usually machined to remove the edge before welding. Methods of weld preparation are as follows:

Machining

Machining of weld preparations can be performed using a variety of tools. Milling machines, bed planers, and shapers are commonly used with carbide cutting tools. It is recommended that any machining be performed dry, i.e., without any cutting lubricants. Lubricants are either oil (hydrocarbon) or water-based. If lubricants are used, the residue must be removed before welding. If not removed, excessive porosity will result.

Sawing

Both band and circular saws are commonly used to make weld preparations. Higher blade speeds and coarser teeth are required than when cutting steel. Recommended blade surface speeds are 8000 sfpm for circular saws and 5000 sfpm for band saws. Band saw blades should have no more than 4 teeth per inch. If circular saws are used, the cut quality can be good enough so that no further preparation is necessary. Band saws usually leave a coarse surface which must be sanded or grinded.

Grinding and Sanding

The use of grinding and/or sanding to form weld preparations has been discouraged in the past, because organic binders in the disc often left behind organic residues which then caused weld porosity. However, there are a number of grinding and sanding discs available today which are specifically formulated for aluminum. These can give excellent results for forming weld preparations on aluminum.

Shearing

Shearing is very useful to cut sheets or plates to size. However, the edge quality is rarely acceptable for welding. It is relatively rough and has a lot of crevices which can trap oils, greases, etc. It is recommended that the edge be smoothed by machining, grinding, or sanding after shearing.

Preweld Cleaning

Once the weld preparation is formed, it must be cleaned before the weld joint is fit together. Cleaning consists of removing any contaminants. These contaminants are as follows:

(1) Oils and Greases

Removal of oils and greases can be performed in one of several ways. First, wiping with a clean rag saturated with a degreasing solvent. This method is very effective. However, the use of many solvents has been severely curtailed in recent times because of environmental concerns. Second, mild alkaline solutions make good degreasers. The part to be degreased can be sprayed with these solutions or dipped into a tank containing them. Since such cleaners are usually water based, it is important to thoroughly dry the part after degreasing. Third, many suppliers sell acid based cleaning solutions for cleaning aluminum. These are usually effective. However, all are acidic and some contain hydrofluoric acid, so caution in their use and disposal is required. Again, since they contain water, the piece must be thoroughly dried before welding.

Whichever method is used, it is important to degrease the part to be welded before performing any of the oxide removal procedures outlined below. Otherwise the oils and greases will be spread by the oxide removal and will be difficult to remove.

(2) Excess Oxides

Once the oils and greases are removed, oxide removal can be performed in several ways. The most common is to use a stainless steel wire brush. The brush should be clean and not previously used on materials other than aluminum. The brush should be relatively flexible and should be used with only light pressure in order to avoid unnecessarily roughening the surface of the aluminum.

Oxide removal can also be performed by immersing the part in a strong alkaline solution. However, these solutions are very corrosive, and can etch the surface of the aluminum, therefore, extreme care must be used.

In some industries, especially the aerospace industry, final oxide removal is performed just before the joint is fit together by mechanically removing the oxide using a steel scraper (identical to those used in woodworking) or by draw filing. Once the cleaning is performed, the joint is fit together as soon as possible. These are very effective methods for oxide removal. However, they are time consuming, costly, and are primarily used in industries where the demand for extremely high quality overrides the additional cost.

Interpass Cleaning

The surface of a weld usually has areas of oxides and weld "smut" on it. This gray to black colored smut is composed of aluminum oxide and magnesium oxide. Before depositing another weld pass, it is recommended that the smut and oxides be removed, because they can cause lack of fusion defects.

The easiest way to remove these oxides is to use a wire brush, either manual or power driven. The wire brush should be clean and used only on aluminum. It should be flexible and used with light pressure.

Backgouging

When making a double-sided weld, it is necessary to remove the metal on the back side to sound metal before depositing the back side weld. If this isn't done and the backside weld is made with no preparation, lack of fusion will often result.

The usual geometry for the backgouged seam is a V preparation with a 60° included angle and a 1/8" (3.2 mm) radius at the base. There are a number of ways to perform this backgouging:

(1) Air Arc or Plasma Arc Gouging

Either of these processes can be used successfully. However, they rely on the skill and steadiness of the operator to obtain a uniform backgouge. In addition, they usually require cleaning up with a grinding disk before welding. This is especially true of air arc gouging, which leaves carbon deposits in the gouged groove. If the carbon isn't removed, porosity on the backside weld can result.

(2) Grinding

A thin [1/8" (3.2 mm)] grinding disk on edge can be used for backgouging. Again, the operator must be skilled in order to produce a uniform gouge.

(3) Machining

Ideally, the best way to get a uniform backgouge is to mount the weld in a milling machine and machine the backgouge. Unfortunately, this usually isn't practical. However, a number of manufacturers supply a pneumatically powered circular saw mounting a 4" (102 mm) diameter milling cutter. This milling cutter is ground to have a tooth form with a 60° V with a 1/8" (3.2 mm) tip radius. The depth of the backgouge is set by setting the cutting depth of the saw. It is relatively easy to set up a straightedge to guide the saw along to get a straight backgouge.

(4) Chipping

Although not used very often, the use of a pneumatic chipping hammer with the appropriate chisel can be a very effective way to backgouge. The problem with this method is the extremely high noise level produced. It is very easy to regulate the cutting depth to get down to sound metal because it is obvious to the operator when sound metal is reached. The effectiveness of this method is very dependent on the geometry of the chisel. The correct geometry is shown in Figure 3.

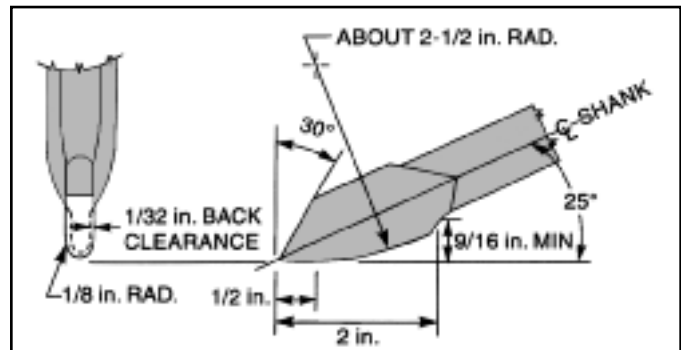

Figure 3: Correct Pneumatic Chisel Geometry for Backgouging Aluminum.

GMAW of Aluminum Alloys

Properties of Aluminum

The engineering use of wrought and cast aluminum base materials continues to increase, and it does so because of the basic properties of this unique material. The more prominent features of aluminum and its alloys are:

- Aluminum is lightweight. It weighs about one third that of steel. A cubic inch of aluminum weighs 0.098 lbs./in.³ compared to steel, which weighs 0.283 lbs/in³.
- Aluminum has a wide range of strength properties that vary from 13,000 tensile for pure aluminum up to 90,000 tensile for the heat treatable aluminum alloys.
- Aluminum provides excellent corrosion resistance in many environments. The thin refractory oxide that forms on the surface of aluminum provides a protective barrier.
- Aluminum is an excellent conductor of heat. It is up to five times more thermally conductive than steel.
- Aluminum is reflective of radiant heat, and the surface finish of aluminum is frequently used to take advantage of this feature.
- Aluminum is widely available in either extruded shapes or wrought sheet in an equally wide range of alloy compositions.
- Aluminum is widely available as a die cast base material.

For welding purposes, an important consideration for welding aluminum is its thermal conductivity. This property has an important facet:

- To compensate for the high rate of thermal conductivity, aluminum requires the use of higher energy modes of metal transfer. Axial spray and pulsed spray are the two recommended GMAW modes of metal transfer for aluminum. The use of the lower energy forms of metal transfer will usually result in incomplete fusion defects.

Modes of Metal Transfer

What is important to note when welding aluminum base material is that the thermal conductivity of the aluminum base material is higher than it is for carbon steel, and because of this the lower energy modes of metal transfer are unable to provide sufficient melting of the base material to ensure good fusion.

Axial spray and pulsed spray metal transfers are the preferred metal transfer modes for aluminum, each of these are capable of providing the required energy levels for base metal melting to assure good fusion.

Table 8 supplies the typical axial spray transfer transition currents related to specific aluminum electrode diameters (note that argon gas is the shielding gas associated with the transition currents). In those cases where helium additions are made to the argon, the required watt energy level (current x voltage) to achieve the transition to axial spray will have to increase. Axial spray is the higher energy transfer mode for GMAW, and aluminum requires the use of higher energy modes of transfer to compensate for the higher thermal conductivity. Because of these two central facts, axial spray is generally applied to aluminum base materials 0.125" (3.2 mm) or greater in material thickness.

Table 8

AXIAL SPRAY TRANSITION CURRENT

Aluminum Electrode Diameter		Shielding Gas	Transition Current
(mm)	Inches		
(0.8)	0.030	100% Argon	90 ± 5 Amps
(0.9)	0.035	100% Argon	110 ± 5 Amps
(1.2)	0.047	100% Argon	135 ± 5 Amps
(1.6)	0.062	100% Argon	180 ± 5 Amps

If available, GMAW-P is able to join thin and thick sections of aluminum. For those materials that are less than or equal to 0.125" (3.2 mm), pulsed spray transfer is the preferred choice. Pulsed spray transfer is more easily able to join materials less than 0.125" (3.2 mm), and this is due to the fact that the average current is lower in magnitude for GMAW-P than axial spray transfer welding current. When compared to axial spray transfer GMAW-P has the following advantages when used for welding aluminum:

- Lower heat input – less distortion.
- Ability to handle poor fit-up.
- Ability to handle thinner materials.
- The lower heat input of GMAW-P reduces the size of the heat affected zone.
- Out-of-position welding is greatly enhanced.

Power Supplies and Wire Drives

The history of the development of power sources for aluminum GMAW welding relates to the development of constant current (CC), or constant voltage (CV) output characteristics. Prior to the development of CV power sources the use of CC or "drooper" type power sources were used exclusively for welding aluminum. Special techniques were required for arc striking and special variable speed wire drives were developed as a solution for the unstable arc length associated with constant current.

Constant current power sources provided excellent penetration uniformity, and they reacted slowly to changing conditions. The slower dynamic response to changes in arc length were desirable for welding thicker sections of aluminum with electrode diameters 3/32" (2.4 mm) and larger. The primary disadvantage of CC power sources is arc starting and the ability to regulate arc length.

In the late 1950s, when selenium rectifiers were employed to provide the CV output characteristics, many aluminum fabricators soon realized there was a problem. The output of the early CV power sources produced wide welding current fluctuations due to changes in arc length, and this was compounded by changes in output due to fluctuations in input power. Because of the higher thermal conductivity of aluminum the current changes that occurred produced variations in weld penetration.

Incomplete fusion defects often accompanied the penetration problems. Because of this, many aluminum fabricators went back to CC power supplies for consistent penetration. As a result of these early difficulties, much of the available aluminum welding literature continues to advocate the use of CC supplies.

Constant voltage power supplies produced since the 1990's demonstrate more consistent output. These newer CV power sources are line voltage compensated, which assures consistent delivery of output. CV enjoys widespread use, and is highly recommended for aluminum gas metal arc welding.

GMAW-P Power Supplies

Pulsed arc power supplies have become much more sophisticated than those of only a few years ago. Early pulsed power supplies had a fixed pulsing frequency based upon multiples of input frequencies, and they usually were 60 and 120Hz. These systems were non-synergic, and they were difficult to set up.

The 1990's introduced newer pulsed power sources that provided synergic control (one knob control) with a high speed amplifier used to control output. In the newer pulsed arc power sources, either an inverter transformer or related Chopper Technology® provide power for the arc, and software is used to direct the output of the power source.

The software developed specifically for these newer power sources provides a wide selection for a range of filler types, diameters, and shielding gas compositions. In most cases the newer power sources provide a wide selection of pulsed spray transfer, synergic CV, and special Pulse on Pulse™ programs for use with aluminum electrodes.

Wire Drives and Controls

Reliable feeding of the softer aluminum solid wire electrodes through a welding torch presents more of a challenge than feeding carbon steel electrodes. Aluminum wire is much less rigid than steel wire and it is harder to push through a GMAW torch. Special wire drives and GMAW guns are available to enhance the feedability of aluminum electrode. They fall into four main categories:

1. Push Type Feeders

Standard wire feeders, employed for carbon steel solid wire electrodes, can also be referred to as "push type feeders." In this type of equipment, a spool of wire is mounted on a spindle located to the rear of the drive. A shielding gas pre-flow and post-flow timer/control should be available. There is a set of drive rolls (two-roll or four-roll), on the feeder which pushes the wire through from the spool mounting device through the torch cable and then through the contact tip.

For aluminum electrode, the use of highly polished "U" groove drive rolls, is recommended. In all of the ensuing scenarios the use of hard shell nylon or Teflon type liners is strongly recommended. This type of system, with some modifications described below, can also be used to feed softer aluminum wire under the following circumstances:

- The gun cable must be kept short, 10-12 ft. (3.0-3.6 m) is the practical maximum length. The shorter the GMAW gun cable, the better the overall performance. Teflon or hard shelled nylon electrode liners must also be employed.
- If 1/16" (1.6 mm) diameter wire is used, either 4043 or 5356 filler alloys can be pushed. The thicker electrodes have higher column strength. Again, Teflon or hard shell nylon electrode liners must be employed.
- 3/64" (1.2 mm) 5356 filler metal can generally be pushed, but 3/64" (1.2 mm) 4043 filler metal will usually result in wire feeding problems if pushed.
- Plastic or aluminum specific inlet and outlet guides and special aluminum contact tips are also recommended.
- U-grooved type drive rolls should be used.

2. Push-Pull Type Feeders

A solution to the problem of feeding either small diameter or softer aluminum wire is to use a "push-pull" feeder. In most push-pull feeders, the pull motor in the welding torch is the "master" motor and the push motor in the cabinet is the "slave" motor.

Wire feed speed is controlled by the motor on the torch handle, and the cabinet contains a motor system designed to provide a slack wire reducing effect on the electrode. This push-pull type of aluminum wire drive system provides the most consistent daily performance when compared to the other type systems. Figure 4 shows a complete push-pull system. Figure 5, on the following page, shows the welding torch up close.

The push-pull systems handle aluminum diameters from 0.030" to 1/16" (0.8 - 1.6 mm). They reliably feed aluminum wire up to 50 ft. (15.2 m) from the control cabinet.



Figure 4: Complete Push-Pull Drive System:

Power Wave® 355M power source, combined with the Power Feed™ 10M wire feeder and push-pull aluminum torch. For more information on this system, request publications E5.146 and E8.267.

3. Push-Pull GMAW Torches

Figure 5 shows a closeup of a push-pull aluminum torch. The bulged area of the gun handle houses the pull drive motor. This permits the use of a more integrated approach for feeding aluminum. The motor in the torch handle is variable torque — constant speed, which permits the use of the wire feed speed control at the wire feeder.



Figure 5: Push-Pull GMAW Aluminum Torch

There are several “after market” add-on welding torches available that can convert most wire feeders to push-pull. These add-on welding torches usually function such that the pull torch in the gun is the “slave” and the push motor in the wire feeder is the “master”.

There is evidence that the more commonly used gun (master) and feeder (slave) arrangement gives more consistent results, but these add-on pull torches have also been shown to be effective.

Both push and push-pull welding torches are available in air-cooled and water-cooled versions. Even the largest air-cooled torches are typically rated at 200 amps maximum at 60% duty cycle for aluminum. It is recommended that water-cooled torches be used for high-volume production or whenever currents over 150 amps will be used.

Welding torches are available in straight barrel pistol grip, curved barrel pistol grip or gooseneck styles. All are acceptable for welding aluminum, however, if curved barrels are used, avoid sharply bent barrels — they will add to wire feeding difficulties.

4. Spool Guns

Another solution for light duty aluminum welding is the spool gun shown in Figure 6. In this system, a 1 lb. (0.5 kg) spool of filler wire is mounted directly on the rear of the GMAW gun, so that it is only pushed a few inches past the drive rolls, shown in inset. These spool guns are usually air-cooled and rated for 200 Amps maximum at 60% duty cycle, so they are not recommended for high current or high duty cycle welding.



Figure 6: Magnum® 250LX Spool Gun

For more information, request publication E12.25.

Aluminum Feeding Enhancements

- Drive Rolls should always be highly polished “U” groove type for aluminum. The “U” groove is designed to cradle the softer electrode without altering its shape and the high polish prevents the accumulation of aluminum oxide in the drive roll groove. Steel electrodes use either knurled rolls or a “V” groove configuration. Drive rolls designed for carbon steel electrodes should not be used for feeding aluminum.



Figure 7: Drive Rolls and Wire Guide for Feeding Aluminum

- Inlet and outlet wire guides for feeding aluminum should be made from teflon, nylon, or other suitable plastic which will not scrape the wire. A typical wire guide for aluminum is shown in Figure 7. Wire guides for steel wire are usually made from steel and should not be used to feed aluminum.
- Torch liners for aluminum welding should be either teflon, nylon or other plastic liner material. Some of these types of aluminum liners will have a short coiled brass liner section located at the front of the plastic liner. Liners for torches made to feed steel are usually made from spirally wound small diameter steel wire. These types of liners should not be used for feeding aluminum. They will shave the aluminum wire and then quickly clog the path.
- Most manufacturers make contact tips specifically for aluminum wire. Aluminum readily expands as it absorbs the heat of the arc. Aluminum contact tips for a given size aluminum wire are designed to accommodate the thermal expansion of the wire — the inside diameter of the contact tip is slightly larger than those for the same size steel wire. Contact tips for welding steel are not suitable for welding aluminum.

Some welders, after encountering aluminum feeding problems, opt to use oversize contact tips, i.e., 1/16” (1.6 mm) tips on 3/64” (1.2 mm) wire. This is usually unacceptable. The contact tip must transfer current to the wire. An oversized tip will not allow consistent current transfer. Arcing in the tip will occur which will produce sharp burrs on the bore of the tip.

Another unacceptable practice is to use a wire straightener and tighten it down hard so that all of the cast is removed from the wire. Because the wire needs cast to make proper contact in the tip, removing all of the cast usually results in burnback.

- The contact tip should be flush with the end of the gas nozzle or slightly recessed [approximately 1/8” (3.2 mm)]. The tip should not extend past the gas nozzle.

Shielding Gas

The recommended shielding gas for welding aluminum up to approximately 1/2" (12.7 mm) in thickness is 100% argon. Above this thickness, where additional energy is needed to melt the material, it is common to use gas mixtures of 75% argon + 25% helium or 75% helium + 25% argon. The use of helium in the arc provides additional energy used to accommodate heavier section thickness welding. It also expands the cross sectional shape of the finished weld giving it a more rounded appearance. Shielding gas flow rates range from 30 to 100 cubic feet/hour (cfh), (14 to 47 L/min). Higher flow rates are employed for wider diameter gas nozzles and when using higher helium two-part blends.

Shielding gas components such as oxygen, hydrogen, or CO₂ should never be employed for aluminum GMAW. Even in trace amounts these gases will adversely affect the weld.

Welding Techniques

The formation of black soot on the surface, or the adjacent areas of a weld, is referred to as smut. It is made up of finely divided oxides of aluminum and magnesium. They usually indicate that adjustments in technique are necessary.

At the onset of learning to weld using aluminum GMAW, the most common mistake made is to hold too long a contact tip to work distance (CTWD). Shorter CTWD's, 1/2" to 5/8" (12.7 - 15.8 mm), are required when welding aluminum. If the CTWD is too long, then the gas shielding will be insufficient. In the absence of adequate shielding gas the weld will become gray, and in the most severe case, the arc may bore into the work piece.

At the start of an aluminum weld, it is not uncommon to get a cold looking weld bead for the first 1/2" (12.7 mm). This is due to the high thermal conductivity of aluminum. This condition can be minimized by using a power supply with a hot start. A common alternative used in the absence of a hot start control is to strike the arc about 1" (25.4 mm) ahead of the nominal weld starting point, and quickly maneuver the arc back to the desired starting point. This action has the effect of providing preheat to the aluminum base material, and it provides improved fusion at the beginning of the weld.

While welding, the torch must be held with a push angle of 5° to 10° (also known as a leading torch angle). If the torch is applied using a drag angle (also known as a lagging torch angle), then the gas shielding will be absent from the molten puddle and the finished weld will appear gray or black.

Care must be taken in extinguishing the arc. Terminating the arc abruptly will result in a deep weld crater that may contain a shrinkage crack in the crater. There are a number of ways to minimize the size and depth of the crater.

- Weld tabs can be used and the weld may be started and terminated on them.
- A power supply with an arc decay control allows the electrode and current to tail off for a predetermined wire feed speed per unit of time. This permits a controlled fill of the aluminum weld crater.

- Near the end of the weld, progressively increase the travel speed. The effect here is to reduce the size of the weld bead and diminish the overall size of the crater. This is known as a "feathering" or "back step" technique.
- At the end of the weld, reverse the direction of the torch to place the crater within the body of the weld bead.

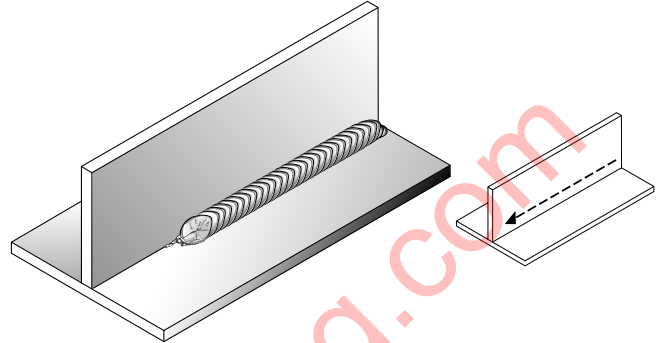

Figure 8: Straight Progression Weld

Some welders learn aluminum GMAW by keeping a very steady, constant motion in the travel direction to make a very smooth weld with a minimum of weld ripples. This is known as a straight progression type weld bead, see Figure 8. Other welders learn to weld by using the back step technique, see Figure 9. Each of these techniques produce a weld with distinct, evenly spaced ripples. Each technique produces acceptable finished welds.

The finished weld should be bright and free from oxides and smut. A "frost line" or cleaning stripe approximately 1/16" to 1/8" (1.6 to 3.2 mm) wide should be visible along each edge of the weld. These stripes show the area where the reverse polarity arc has removed the oxide from the aluminum surface. If the weld metal is black or gray, or if the cleaning stripes are not present, something is wrong. The most likely causes are either the arc length is too long or the torch angle is wrong. If some weld smut is present outside these areas - this is expected. There will also be some weld smut present at weld starts, stops and at internal and external corners. More smut will be present when using 5XXX filler than with 4XXX filler.

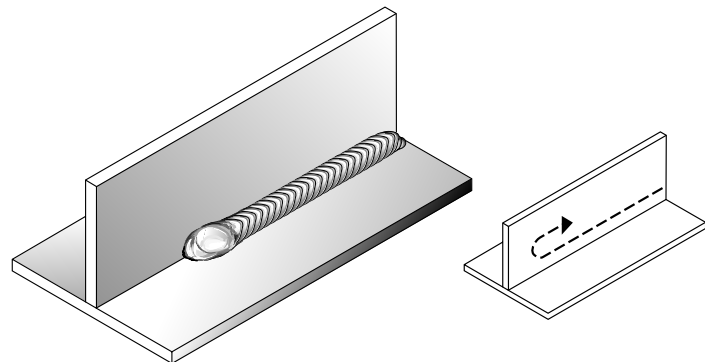

Figure 9: A Back Step Technique Weld

Weld Defects — Causes and Cures

Some weld defects — or discontinuities — may be small enough that they don't seriously impair the mechanical properties of the weld joint. Other discontinuities may cause immediate joint failure. The effects of other discontinuities may be more insidious. It is not the purpose of this section to assess the acceptability or rejectability of specific discontinuities. Instead, the appearance of the various types of weld defects will be illustrated and methods to eliminate or minimize these defects.

Cracking

Cracking occurs when a combination of a susceptible microstructure or chemistry and a sufficiently high solidification stress are present. If you reduce the stress or change the microstructure or chemistry, the cracking can be eliminated.

All weld cracking in aluminum is caused by hot cracking. That is, it takes place during weld solidification.

Crater Cracking

If the arc is extinguished rapidly, there isn't enough filler metal present to avoid forming a deep "crater". The geometry of the crater locally intensifies the solidification stresses. If they are high enough, a crack forms in and around the crater.

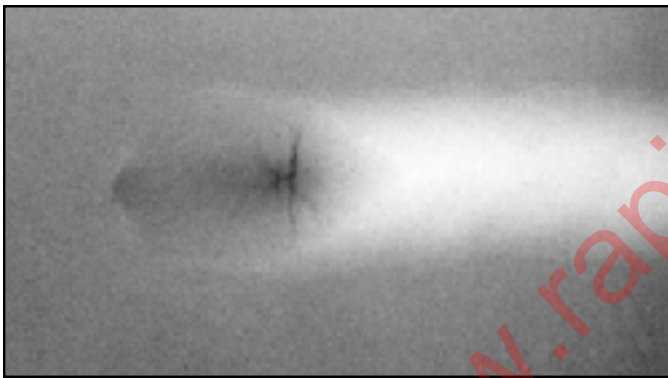

Figure 10: Radiograph Showing a Crater Crack

In order to eliminate crater cracking, the geometric discontinuity of the crater must be minimized, i.e., the crater must be filled in as much as possible. There are several methods to prevent crater cracking:

- Use a power supply with a crater fill option.
- Rapidly restrike and extinguish the arc a few times while keeping the wire tip in the crater. This will build up the crater.
- Run the weld bead to the end of the workpiece, then reverse direction and increase travel speed in the new travel direction.

Longitudinal Cracking

Longitudinal cracking occurs relatively frequently. A radiograph of a longitudinal weld crack is shown in Figure 11.

Weld cracking can usually be eliminated by taking following precautions:

- Heat treatable alloys are crack sensitive and will crack if welded autogenously. Make sure you add filler metal.
- Make sure you add enough filler metal in welding any alloy. Do not deposit thin, concave groove welds or small or concave fillets. They may crack. Weld passes in both groove welds and fillet welds should be convex.
- If cracking is encountered in making a square butt weld, try a V-weld preparation. It will allow the addition of more filler metal. Similarly, if you're using a bevel prep, go to a V-prep.
- Reduce the clamping pressure to allow the material to move slightly during solidification. Occasionally high stress is caused by the joint geometry, which may need to be changed.



Figure 11: Radiograph Showing Longitudinal Weld Cracking

Liquation Cracking

Liquation cracking is common in lap and fillet welds in thin heat-treatable alloys. It usually is not seen in the nonheat-treatable alloys or in butt joints. It manifests itself as a short longitudinal crack in the parent material on the back side of a weld. It is caused by the melting of low melting point compounds which tend to segregate to the grain boundaries in heat-treatable alloys. In order to minimize it, weld penetration into the parent metal needs to be controlled in lap and fillet welds. Welds having 30 or 40% penetration into the parent metal will almost never cause a crack, while welds penetrating 70 – 80% into the parent metal will often cause a small crack on the back side of a weld.

Incomplete Penetration

A radiograph of a weld showing incomplete penetration is shown in Figure 12. Incomplete penetration is often caused by insufficient weld current at a welding travel speed that is too high. However the use of an arc voltage that is too high can also result in the arc bridging the weld root and not penetrating completely.

Care must also be taken in backgouging a two-sided weld. Insufficient backgouging can sometimes result in incomplete penetration. It is sometimes surprising how deep the backgouge must be to get to sound metal.

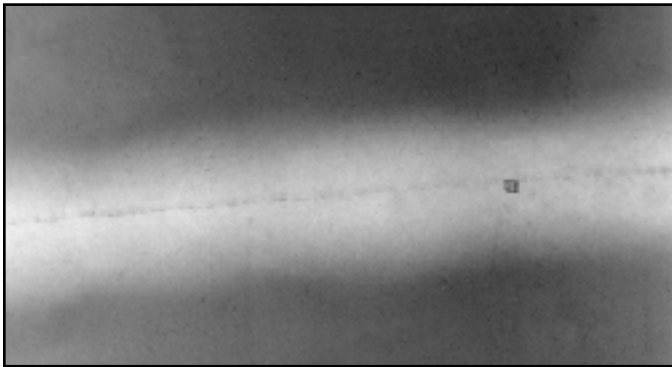

Figure 12: Radiograph Showing Incomplete Penetration

Incomplete Fusion

Incomplete fusion, Figure 13, is usually caused by welding over heavy oxides, insufficient interpass cleaning, or poor bead placement. Heavy oxides must be removed before welding. The weld smut and/or oxides must be removed before making another weld pass.

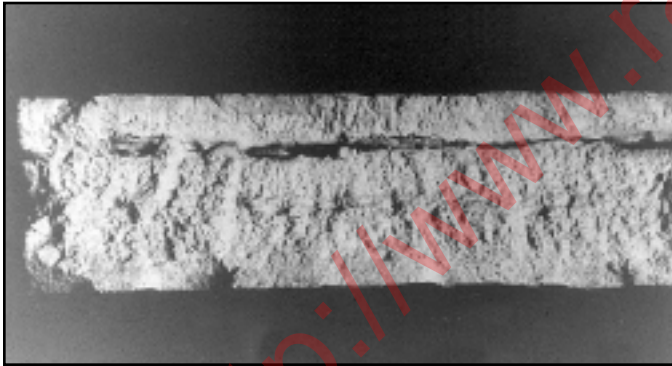

Figure 13: Fracture Surface of a Weld with Incomplete Fusion

Porosity

Figure 14 shows excessive porosity in a fracture surface of a weld. Porosity in aluminum welds is caused by bubbles of hydrogen gas which are trapped in the welds as it cools. It has already been discussed that the source of this hydrogen is oils, greases, or water vapor that is dissociated by the welding arc. In order to control weld porosity, the sources of these contaminants must be eliminated. It is also helpful when welding in the vertical position, to use an upward progression, rather than the downward progression usually used to weld steel, to minimize weld porosity.

Copper Contamination

Copper contamination will also appear white on a radiograph, as seen in Figure 15. Copper contamination is usually larger and "fuzzier" than tungsten, which appears as individual small particles.

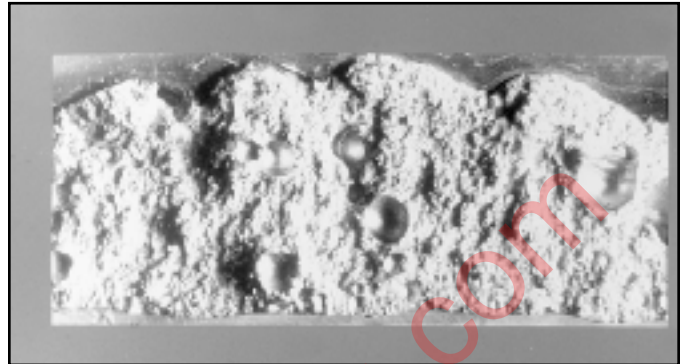

Figure 14: Fracture Surface of a Weld with Excessive Porosity

Copper contamination is often encountered in GMAW and is caused when the wire burns back and fuses to the copper contact tip. The copper and aluminum quickly alloy and deposit copper in the aluminum weld. If this occurs, the copper contamination must be ground out and repaired because the aluminum/copper alloy that is deposited is very brittle.

Copper contamination can also be caused by copper backing bars or copper tooling. While the use of copper backing bars is acceptable, the joint preparation must be such that the arc is not allowed to impinge directly on the copper bar. If it does, the copper bar will melt and alloy with the aluminum. While copper backing bars are acceptable, wide root openings must be avoided.

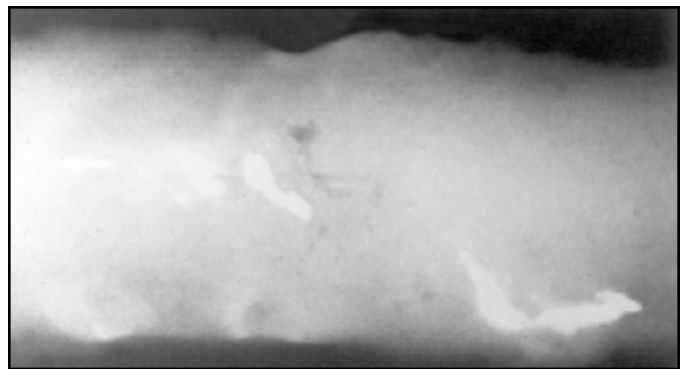

Figure 15: Radiograph Showing Copper Contamination
(Copper contamination shows up as lighter and irregularly shaped areas.)

Solving Problems in Qualifying Weld Procedures

Many fabricators encounter difficulties in qualifying welding procedures or welders for aluminum. Most codes require the use of reduced section tensile tests and guided bend tests for procedure qualification. Therefore, we will discuss these two requirements:

Difficulties in Meeting Tensile Test Requirements

All codes have minimum tensile test values. Samples removed from procedure qualification test plates must meet these values. However, the weld does not have to meet the same minimum requirements as the parent material. For example, all codes require that 6061-T6 material have a minimum tensile strength of 40 ksi (276 MPa). Welds in 6061-T6 only have to meet 24 ksi (165 MPa) minimum. It is important to understand what is required for the specific alloy being used.

There are several reasons why samples fail tensile testing. For heat-treatable alloys, usually it is because excessive heat input has been used. Common reasons for excessive heat input are:

- Use of excessive preheat. Preheat should be no more than 200°F (93°C) and isn't needed unless the ambient temperature is below 32°F (0°C).
- Interpass temperature that is too high. Maximum interpass temperature should be 250°F (121°C).
- Technique issues, such as the use of very wide weave passes, which can cause heat input to be excessive. Generally stringer passes should be used, although weaving is acceptable as long as the weave width is no wider than four times the wire diameter.

Weld defects can also cause premature tensile failures. Observe the fracture face of the failed tensile sample. The presence of weld defects should be fairly obvious. Lack of fusion or lack of penetration defects are especially prone to cause tensile failure.

Where the code requires the tensile sample to meet 40 ksi (276 MPa) minimum tensile strength, the use of 5356 is **not** recommended. Higher strength filler alloys, such as 5183 or 5556, are recommended for these applications.

Difficulties in Meeting Bend Test Requirements

Most bend test failures are caused by the welder's lack of familiarity with the bend test requirements for aluminum welds. Some points to remember are as follows:

1. The ductility of aluminum welds is lower than that of steel welds. Ensure the test radius is correct for the alloy under test. Figure 16, on the following page, shows the bend test requirements of AWS D1.2.
2. If the bend sample fails with little or no distortion before breaking, the most likely cause is a defect in the weld. Any lack of fusion or insufficient penetration in the weld will quickly open up on bending and cause the sample to break in half. A visual examination of the fracture surface will reveal these defects.

3. Ensure that the bend test sample preparation is correct.
 - a. Make sure grinding or machining marks go along the length of the sample, not across it. Marks going across the sample can act as crack initiation sites.
 - b. Don't leave square-machined corners on the sample. All codes allow a radius at the corners of 1/2 the sample thickness or 1/4" (6.4 mm), whichever is less. Adhering to this radius reduces the probability of initiating a crack in the corners.
4. Special precautions are necessary when testing welds in 6061 or other M23 (per AWS) or P23 (per ASME Section IX) materials because of their limited ductility. In recognition of this, both AWS D1.2 and ASME Section IX require bend test samples in 6061 and other M23 materials to be machined to 1/8" (3.2 mm) thickness, instead of the normal 3/8" (9.5 mm) thickness. If 6061 samples are machined to 3/8" (9.5 mm) thickness and tested around a standard radius mandrel, they often fail. AWS D1.2 alternatively allows samples in M23 materials to be machined to 3/8" (9.5 mm) thick and annealed before testing, but ASME Section IX has no such provision.
5. The use of the standard plunger-type bend tester is responsible for most bend test failures. This test fixture works well for steel because the mechanical properties of the weld, HAZ, and parent material are all similar. However, in aluminum, the HAZs are usually much weaker than the remainder of the sample. If the sample is tested in a plunger-type tester, the bend strain is concentrated in the HAZ. Instead of bending smoothly around the mandrel, the sample often forms a sharp kink at the HAZ and the sample fails at the kink.

A much better test for welded aluminum bend samples is the Wraparound Guided Bend Test, shown in Figure 17, on the following page. In this test, the sample is pulled around the mandrel and forced to stay in contact with it. These test jigs are often made from rotary tubing benders. Both AWS D1.2 and ASME Section IX encourage the use of these testers for aluminum.

Figure 16: Bend Test Requirements from AWS D1.2 using Plunger Type Tester

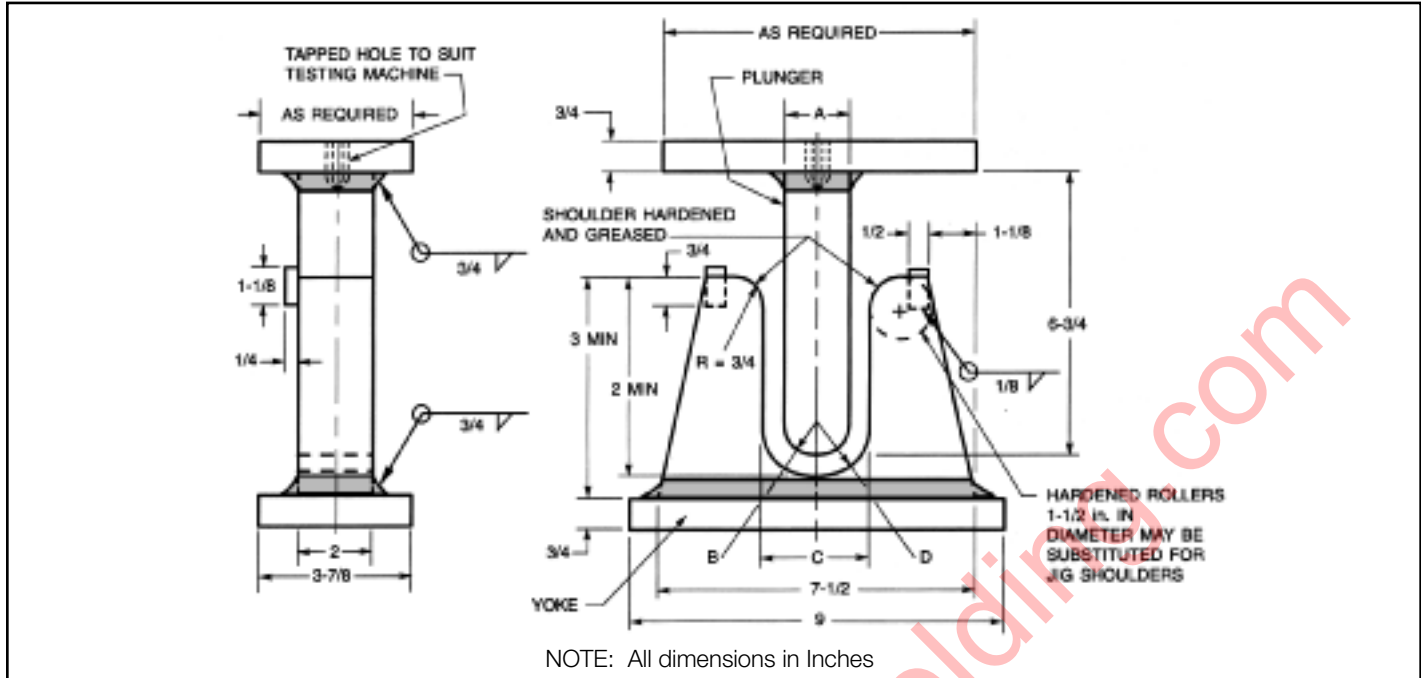

Thickness of Specimen (Inches)	A (Inches)	B (Inches)	C (Inches)	D (Inches)	Materials
3/8 t	1-1/2 4t	3/4 2t	2-3/8 6t + 1/8	1-3/16 3t + 1/16	M21 and M22
1/8 t (<1/8)	2-1/16 16-1/2t	1-1/32 8-1/4t	2-3/8 18-1/2t + 1/16	1-3/16 9-1/4t + 1/32	M23 and F23 Welds
3/8 t	2-1/2 6-2/3t	1-1/4 3-1/3t	3-3/8 8-2/3t + 1/8	1-11/16 4-1/3t + 1/16	M25 and Annealed M23
3/8 t	3 8t	1-1/2 4t	3-7/8 10t + 1/8	1-15/16 5t + 1/16	M27 and Annealed M24

Figure 17: Bend Test Requirements for Wraparound Bend Test Fixture

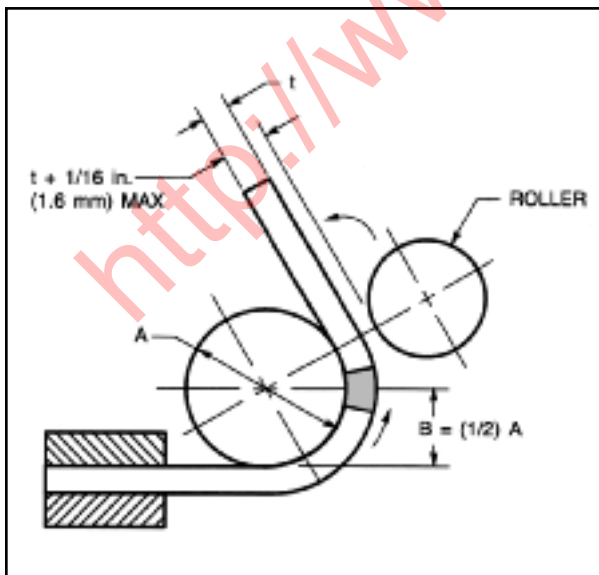

Thickness of Specimen Inches	A (Inches)	B (Inches)	Materials
3/8 t	1-1/2 4t	3/4 2t	M21 and M22
1/8 t (<1/8)	2-1/16 16-1/2t	1-1/32 8-1/4t	M23 and F23 Welds
3/8 t	2-1/2 6-2/3t	1-1/4 3-1/3t	M25 and Annealed M23
3/8 t	3 8t	1-1/2 4t	M27 and Annealed M24

Notes:

1. Dimensions not shown are the option of the designer. The essential consideration is to have adequate rigidity so that the jig parts will not spring.
2. The specimen shall be firmly clamped on one end so that there is no sliding of the specimen during the bending operation.
3. Test specimens shall be removed from the jig when the outer roll has been removed 180° from the starting point.

General Welding Guidelines

Typical Melting Rates for Aluminum Electrodes

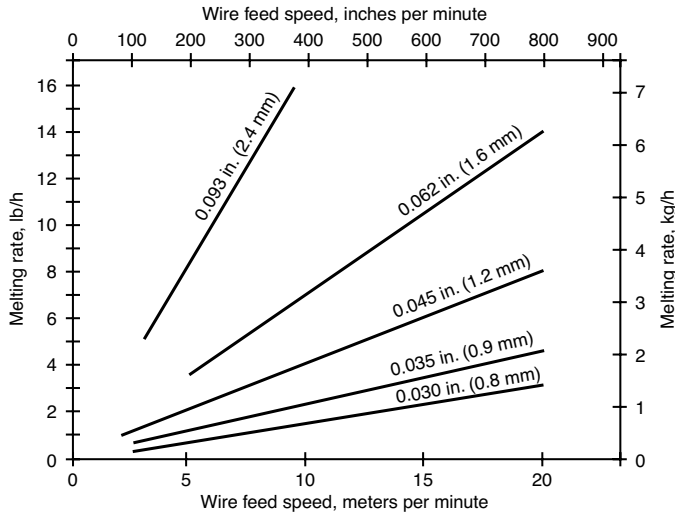

Welding Current vs WFS for ER4043 Aluminum Electrodes at a Fixed Stickout

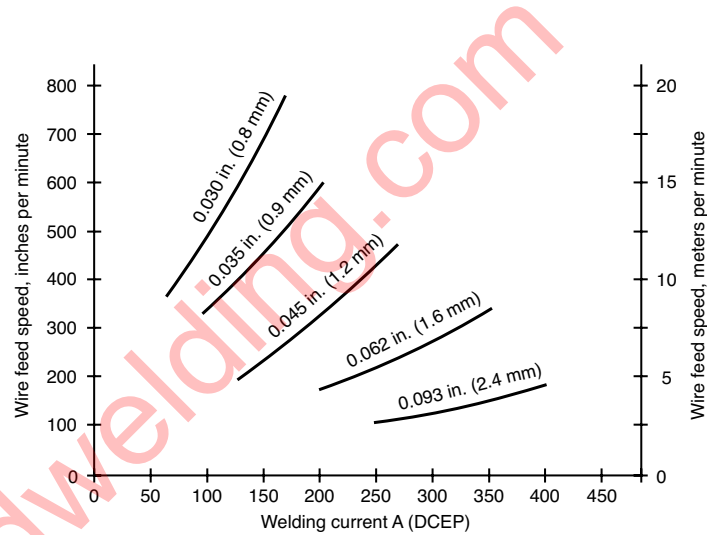

Welding Current vs WFS for ER5356 Aluminum Electrodes at a Fixed Stickout

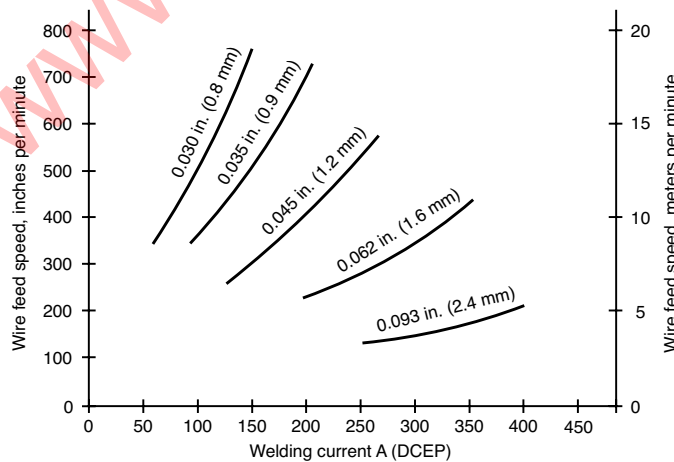

Welding Joint Designs for Aluminum GMAW
Groove Welding — Flat, Horizontal, Vertical and Overhead

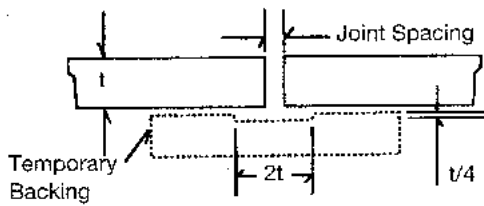

(A)



(B)

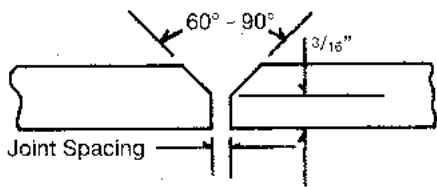

(C)

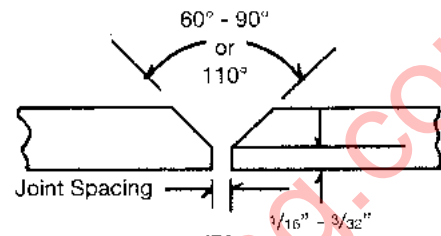

(D)

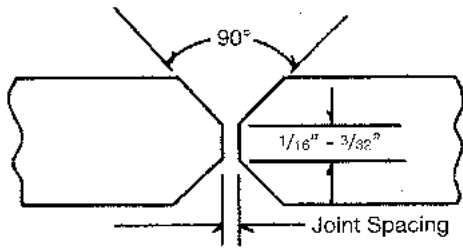

(E)

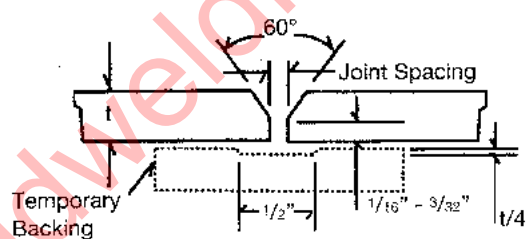

(F)

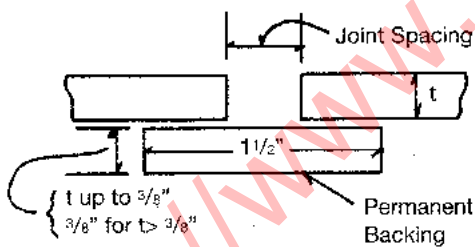

(G)

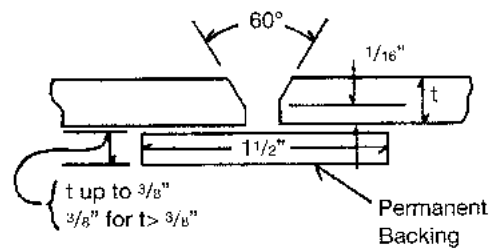

(H)



(I)

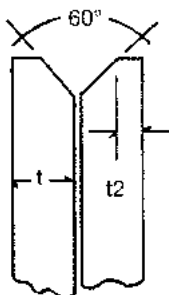

(J)

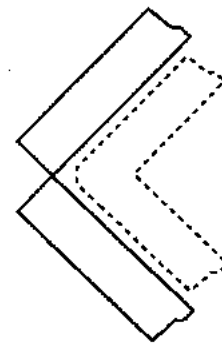

(K)

Welding Guidelines for Aluminum GMAW
Groove Welding — Flat, Horizontal, Vertical and Overhead

Plate Thickness	Weld Position ⁽¹⁾	Edge Prep ⁽²⁾	Joint Spacing In. (mm)	Weld Passes	Electrode Diameter In. (mm)	Welding Current ⁽³⁾ (Amps) (DC+)	Arc Voltage ⁽³⁾ (Volts)	Argon Gas Flow CFH (L/min.)	Travel Speed ipm (M/min.)	Approx. Electrode Consump. (lbs/100 ft)
1/16" (2 mm)	F	A	None	1	0.030 (0.8)	70-110	15-20	25 (12)	25 - 45 (0.64 - 1.14)	1.5
	F	G	3/32 (2.4)	1	0.030 (0.8)	70-110	15-20	25 (12)	25 - 45 (0.64 - 1.14)	2
3/32" (2 mm)	F	A	None	1	0.030-3/64 (0.8 - 1.2)	90-150	18-22	30 (14)	25 - 45 (0.64 - 1.14)	1.8
	F, V, H, O	G	1/8 (3.2)	1	0.030 (0.8)	110-130	18-23	30 (14)	25 - 30 (0.64 - 0.76)	2
1/8" (3 mm)	F, V, H	A	0 - 3/32 (0 - 2.4)	1	0.030 - 3/64 (0.8 - 1.2)	120-150	20-24	30 (14)	24 - 30 (0.60 - 0.76)	2
	F, V, H, O	G	3/16 (4.8)	1	0.030 - 3/64 (0.8 - 1.2)	110-135	19-23	30 (14)	18 - 28 (0.45 - 0.71)	3
3/16" (5 mm)	F, V, H	B	0 - 1/16 (0 - 1.6)	1F, 1R	0.030 - 3/64 (0.8 - 1.2)	130-175	22-26	35 (16)	24 - 30 (0.60 - 0.76)	4
	F, V, H	F	0-1/16 (0 - 1.6)	1	3/64 (1.2)	140-180	23-27	35 (16)	24 - 30 (0.60 - 0.76)	5
	O	F	0-1/16 (0 - 1.6)	2F	3/64 (1.2)	140-175	23-27	60 (28)	24 - 30 (0.60 - 0.76)	5
	F, V	H	3/32 - 3/16 (2.4 - 4.8)	2	3/64 - 1/16 (1.2 - 1.6)	140-185	23-27	35 (16)	24 - 30 (0.60 - 0.76)	8
	H, O	H	3/16 (4.8)	3	3/64 (1.2)	130-175	23-27	60 (28)	25 - 35 (0.63 - 0.89)	10
1/4" (6 mm)	F	B	0 - 3/32 (0 - 2.4)	1F, 1R	3/64-1/16 (1.2 - 1.6)	175-200	24-28	40 (19)	24 - 30 (0.60 - 0.76)	6
	F	F	0 - 3/32 (0 - 2.4)	2	3/64-1/16 (1.2 - 1.6)	185-225	24-29	40 (19)	24 - 30 (0.60 - 0.76)	8
	V, H	F	0 - 3/32 (0 - 2.4)	3F, 1R	3/64 (1.2)	165-190	25-29	45 (21)	25 - 35 (0.63 - 0.89)	10
	O	F	0 - 3/32 (0 - 2.4)	3F, 1R	3/64, 1/16 (1.2 - 1.6)	180-200	25-29	60 (28)	25 - 35 (0.63 - 0.89)	10
	F, V	H	1/8 - 1/4 (3.2 - 6.4)	2 - 3	3/64-1/16 (1.2 - 1.6)	175-225	25-29	40 (19)	24 - 30 (0.60 - 0.76)	12
	O, H	H	1/4 (6.4)	4 - 6	3/64-1/16 (1.2 - 1.6)	170-200	25-29	60 (28)	25 - 40 (0.63 - 1.02)	12
3/8" (10 mm)	F	C - 90°	0 - 3/32 (0 - 2.4)	1F, 1R	1/16 (1.6)	225-290	26-29	50 (24)	20 - 30 (0.51 - 0.76)	16
	F	F	0 - 3/32 (0 - 2.4)	2F, 1R	1/16 (1.6)	210-275	26-29	50 (24)	24 - 35 (0.60 - 0.89)	18
	V, H	F	0 - 3/32 (0 - 2.4)	3F, 1R	1/16 (1.6)	190-220	26-29	55 (26)	24 - 30 (0.60 - 0.76)	20
	O	F	0 - 3/32 (0 - 2.4)	5F, 1R	1/16 (1.6)	200-250	26-29	80 (38)	25 - 40 (0.63 - 1.02)	20
	F, V	H	1/4 - 3/8 (6.4 - 9.5)	4	1/16 (1.6)	210-290	26-29	50 (24)	24 - 30 (0.60 - 0.76)	35
	O, H	H	3/8 (9.5)	8 - 10	1/16 (1.6)	190-260	26-29	80 (38)	25-40 (0.63 - 1.02)	50
3/4" (19 mm)	F	C-60°	0 - 3/32 (0 - 2.4)	3F, 1R	3/32 (2.4)	340-400	26-31	60 (28)	14 - 20 (0.36 - 0.51)	50
	F	F	0 - 1/8 (0 - 3.2)	4F, 1R	3/32 (2.4)	325-375	26-31	60 (28)	16 - 20 (0.41 - 0.76)	70
	V, H, O	F	0 - 1/16 (0 - 1.6)	8F, 1R	1/16 (1.6)	240-300	26-30	80 (38)	24 - 30 (0.60 - 0.76)	75
	F	E	0 - 1/16 (0 - 1.6)	3F, 3R	1/16 (1.6)	270-330	26-30	60 (28)	16 - 24 (0.41 - 0.61)	70
	V, H, O	E	0 - 1/16 (0 - 1.6)	6F, 6R	1/16 (1.6)	230-280	26-30	80 (38)	16 - 24 (0.41 - 0.61)	75

(1) F = Flat; V = Vertical; H = Horizontal; O = Overhead. (2) See joint designs on page 24. (3) For 5xxx series electrodes, use a welding current in the high side of the range and an arc voltage in the lower portion of the range. 1XXX, 2XXX and 4XXX series electrodes would use the lower currents and higher arc voltages.

Welding Guidelines for Aluminum GMAW
Fillet and Lap Welding — Flat, Horizontal, Vertical and Overhead

Plate Thickness ⁽¹⁾	Weld Position ⁽²⁾	Weld Passes ⁽³⁾	Electrode Diameter In. (mm)	Welding Current ⁽⁴⁾ (Amps) (DC+)	Arc Voltage ⁽⁴⁾ (Volts)	Argon Gas Flow CFH (L/min.)	Travel Speed ipm (M/min.)	Approx. Electrode Consump. (lbs/100 ft)
3/32" (2 mm)	F, V, H, O	1	0.030 (0.8)	100-130	18-22	30 (14)	24 - 30 (0.60 - 0.76)	1.8
1/8" (3 mm)	F	1	0.030 - 3/64 (0.8 - 1.2)	125-150	20-24	30 (14)	24 - 30 (0.60 - 0.76)	2
	V, H	1	0.030 (0.8)	110-130	19-23	30 (14)	24 - 30 (0.60 - 0.76)	2
	O	1	0.030 - 3/64 (0.8 - 1.2)	115-140	20-24	40 (19)	24 - 30 (0.60 - 0.76)	2
3/16" (5 mm)	F	1	3/64 (1.2)	180-210	22-26	30 (14)	24 - 30 (0.60 - 0.76)	4.5
	V, H	1	0.030 - 3/64 (0.8 - 1.2)	130-175	21-25	35 (16)	24 - 30 (0.60 - 0.76)	4.5
	O	1	0.030 - 3/64 (0.8 - 1.2)	130-190	22-26	45 (21)	24 - 30 (0.60 - 0.76)	4.5
1/4" (6 mm)	F	1	3/64 - 1/16 (1.2 - 1.6)	170-240	24-28	40 (19)	24 - 30 (0.60 - 0.76)	7
	V, H	1	3/64 (1.2)	170-210	23-27	45 (21)	24 - 30 (0.60 - 0.76)	7
	O	1	3/64 - 1/16 (1.2 - 1.6)	190-220	24-28	60 (28)	24 - 30 (0.60 - 0.76)	7
3/8 (10 mm)	F	1	1/16 (1.6)	240-300	26-29	50 (24)	18 - 25 (0.46 - 0.64)	17
	H, V	3	1/16 (1.6)	190-240	24-27	60 (28)	24 - 30 (0.60 - 0.76)	17
	O	3	1/16 (1.6)	200-240	25-28	85 (40)	24 - 30 (0.60 - 0.76)	17
3/4 (19 mm)	F	4	3/32 (2.4)	360-380	26-30	60 (28)	18 - 25 (0.46 - 0.64)	66
	H, V	4-6	1/16 (1.6)	260-310	25-29	70 (33)	24 - 30 (0.60 - 0.76)	66
	O	10	1/16	275-310 (1.6)	25-29	85	24 - 30 (40)	66 (0.60 - 0.76)

⁽¹⁾ Metal thickness of 3/4" or greater for fillet welds sometimes employ a double vee bevel of 50° or greater included vee with 3/32" to 1/8" land thickness on the abutting member. ⁽²⁾ F = Flat; V = Vertical; H = Horizontal; O = Overhead. ⁽³⁾ Number of weld passes and electrode consumption given for weld on one side only. ⁽⁴⁾ For 5xxx series electrodes, use a welding current in the high side of the range and an arc voltage in the lower portion of the range. 1xxx, 2xxx and 4xxx series electrodes would use the lower currents and higher arc voltages.

SAFE PRACTICES

Introduction. The general subject of safety and safety practices in welding, cutting, and allied processes is covered in ANSI Z49.1⁸, “Safety in Welding and Cutting,” and ANSI Z49.2⁹. “Fire Prevention in the Use of Welding and Cutting Processes.” The handling of compressed gases is covered in CGA P-1¹⁰.

Personnel should be familiar with the safe practices discussed in these documents, equipment operating manuals, and Material Safety Data Sheets (MSDS) for consumables.

In addition to the hazards discussed in the Arc Welding Safety Precautions following this section, be familiar with the safety concerns discussed below.

Safe Handling of Shielding Gas Cylinders and Regulators. Compressed gas cylinders should be handled carefully and should be adequately secured when in use. Knocks, falls, or rough handling may damage cylinders, valves, or fuse plugs and cause leakage or accident. Valve protecting caps, when supplied, should be kept in place (handtight) until the connecting of container equipment.

Cylinder Use. The following should be observed when setting up and using cylinders of shielding gas:

1. Properly secure the cylinder.
2. Before connecting a regulator to the cylinder valve, the valve should momentarily be slightly opened and closed immediately (opening) to clear the valve of dust or dirt that otherwise might enter the regulator. The valve operator should stand to one side of the regulator gauges, never in front of them.
3. After the regulator is attached, the adjusting screw should be released by turning it counter-clockwise. The cylinder valve should then be opened slowly to prevent a too-rapid surge of high pressure gas into the regulator.
4. The source of the gas supply (i.e., the cylinder valve) should be shut off if it is to be left unattended.

Gases. The major toxic gases associated with GMAW welding are ozone, nitrogen dioxide, and carbon monoxide. Phosgene gas could also be present as a result of thermal or ultraviolet decomposition of chlorinated hydrocarbon cleaning agents located in the vicinity of welding operations, such as trichlorethylene and perchlorethylene. **DEGREASING OR OTHER CLEANING OPERATIONS INVOLVING CHLORINATED HYDROCARBONS SHOULD BE SO LOCATED THAT VAPORS FROM THESE OPERATIONS CANNOT BE REACHED BY RADIATION FROM THE WELDING ARC.**

Ozone. The ultraviolet light emitted by the GMAW arc acts on the oxygen in the surrounding atmosphere to produce ozone, the amount of which will depend upon the intensity and the wave length of the ultraviolet energy, the humidity, the amount of screening afforded by any welding fumes, and other factors. The ozone concentration will generally be increased with an increase in welding current, with the use of argon as the shielding gas, and when welding highly reflective metals. If the ozone cannot be reduced to a safe level by ventilation or process variations, it will be necessary to supply fresh air to the welder either with an air supplied respirator or by other means.

Nitrogen Dioxide. Some test results show that high concentrations of nitrogen dioxide are found only within 6 in. (152 mm) of the arc. With normal natural ventilation, these concentrations are quickly reduced to safe levels in the welder’s breathing zone, so long as the welder keeps his head out of the plume of fumes (and thus out of the plume of welding-generated gases). Nitrogen dioxide is not thought to be a hazard in GMAW.

Carbon Monoxide. CO shielding used with the GMAW process will be dissociated by the heat of the arc to form carbon monoxide. Only a small amount of carbon monoxide is created by the welding process, although relatively high concentrations are formed temporarily in the plume of fumes. However, the hot carbon monoxide oxidizes to CO so that the concentrations of carbon monoxide become insignificant at distances of more than 3 or 4 in. (76 or 102 mm) from the welding plume.

Under normal welding conditions there should be no hazard from this source. When the welder must work with his head over the welding arc, or with the natural ventilation moving the plume of fumes towards his breathing zone, or where welding is performed in a confined space, ventilation adequate to deflect the plume or remove the fumes and gases must be provided. Because shielding gases can displace air, use special care to insure that breathing air is safe when welding in a confined space. (See ANSI Z49.1.)

Metal Fumes. The welding fumes generated by GMAW can be controlled by general ventilation, local exhaust ventilation, or by respiratory protective equipment as described in ANSI Z49.1. The method of ventilation required to keep the level of toxic substances within the welder’s breathing zone below acceptable concentrations is directly dependent upon a number of factors. Among these are the material being welded, the size of the work area, and the degree of the confinement or obstruction to normal air movement where the welding is being done. Each operation should be evaluated on an individual basis in order to determine what will be required. Exposure limits for toxic substances associated with welding, and designated as time-weighted average threshold limit values (TLV) and ceiling values, have been established by the American Conference of Governmental Industrial Hygienists (ACGIH) and Permissible Exposure Limits (PEL) by the Occupational Safety and Health Administration (OSHA). Compliance with these acceptable levels can be checked by sampling the atmosphere under the welder’s helmet or in the immediate vicinity of the helper’s breathing zone. The principle composition or particulate matter (welding fume) which may be present within the welder’s breathing zone are listed on the MSDS for the consumable being used. Sampling should be in accordance with ANSI/AWS F1.1, Method for Sampling Airborne Particulates Generated by Welding and Allied Processes.

⁸ ANSI Z49.1 is available from the American Welding Society, 550 N.W. LeJeune Road, Miami, Florida 33126. It may also be downloaded at no charge from the www.aws.org website.

⁹ ANSI Z49.2 is available from the American National Standards Institute, 11 West 42nd Street, New York, NY 10036.

¹⁰ CGA P-1 is available from the Compressed Gas Association, Inc., 1235 Jefferson Davis Highway, Suite 501, Arlington, VA 22202.

⚠ WARNING

⚠ CALIFORNIA PROPOSITION 65 WARNINGS ⚠

Diesel engine exhaust and some of its constituents are known to the State of California to cause cancer, birth defects, and other reproductive harm.

The Above For Diesel Engines

The engine exhaust from this product contains chemicals known to the State of California to cause cancer, birth defects, or other reproductive harm.

The Above For Gasoline Engines

ARC WELDING CAN BE HAZARDOUS. PROTECT YOURSELF AND OTHERS FROM POSSIBLE SERIOUS INJURY OR DEATH. KEEP CHILDREN AWAY. PACEMAKER WEARERS SHOULD CONSULT WITH THEIR DOCTOR BEFORE OPERATING.

Read and understand the following safety highlights. For additional safety information, it is strongly recommended that you purchase a copy of "Safety in Welding & Cutting - ANSI Standard Z49.1" from the American Welding Society, P.O. Box 351040, Miami, Florida 33135 or CSA Standard W117.2-1974. A Free copy of "Arc Welding Safety" booklet E205 is available from the Lincoln Electric Company, 22801 St. Clair Avenue, Cleveland, Ohio 44117-1199.

BE SURE THAT ALL INSTALLATION, OPERATION, MAINTENANCE AND REPAIR PROCEDURES ARE PERFORMED ONLY BY QUALIFIED INDIVIDUALS.



FOR ENGINE powered equipment.

1.a. Turn the engine off before troubleshooting and maintenance work unless the maintenance work requires it to be running.



1.b. Operate engines in open, well-ventilated areas or vent the engine exhaust fumes outdoors.



1.c. Do not add the fuel near an open flame welding arc or when the engine is running. Stop the engine and allow it to cool before refueling to prevent spilled fuel from vaporizing on contact with hot engine parts and igniting. Do not spill fuel when filling tank. If fuel is spilled, wipe it up and do not start engine until fumes have been eliminated.

1.d. Keep all equipment safety guards, covers and devices in position and in good repair. Keep hands, hair, clothing and tools away from V-belts, gears, fans and all other moving parts when starting, operating or repairing equipment.

1.e. In some cases it may be necessary to remove safety guards to perform required maintenance. Remove guards only when necessary and replace them when the maintenance requiring their removal is complete. Always use the greatest care when working near moving parts.



1.f. Do not put your hands near the engine fan. Do not attempt to override the governor or idler by pushing on the throttle control rods while the engine is running.

1.g. To prevent accidentally starting gasoline engines while turning the engine or welding generator during maintenance work, disconnect the spark plug wires, distributor cap or magneto wire as appropriate.



1.h. To avoid scalding, do not remove the radiator pressure cap when the engine is hot.



ELECTRIC AND MAGNETIC FIELDS may be dangerous

2.a. Electric current flowing through any conductor causes localized Electric and Magnetic Fields (EMF). Welding current creates EMF fields around welding cables and welding machines

2.b. EMF fields may interfere with some pacemakers, and welders having a pacemaker should consult their physician before welding.

2.c. Exposure to EMF fields in welding may have other health effects which are now not known.

2.d. All welders should use the following procedures in order to minimize exposure to EMF fields from the welding circuit:

2.d.1. Route the electrode and work cables together - Secure them with tape when possible.

2.d.2. Never coil the electrode lead around your body.

2.d.3. Do not place your body between the electrode and work cables. If the electrode cable is on your right side, the work cable should also be on your right side.

2.d.4. Connect the work cable to the workpiece as close as possible to the area being welded.

2.d.5. Do not work next to welding power source.

Mar '95



ELECTRIC SHOCK can kill.

- 3.a. The electrode and work (or ground) circuits are electrically "hot" when the welder is on. Do not touch these "hot" parts with your bare skin or wet clothing. Wear dry, hole-free gloves to insulate hands.
- 3.b. Insulate yourself from work and ground using dry insulation. Make certain the insulation is large enough to cover your full area of physical contact with work and ground.

In addition to the normal safety precautions, if welding must be performed under electrically hazardous conditions (in damp locations or while wearing wet clothing; on metal structures such as floors, gratings or scaffolds; when in cramped positions such as sitting, kneeling or lying, if there is a high risk of unavoidable or accidental contact with the workpiece or ground) use the following equipment:

- Semiautomatic DC Constant Voltage (Wire) Welder.
 - DC Manual (Stick) Welder.
 - AC Welder with Reduced Voltage Control.
- 3.c. In semiautomatic or automatic wire welding, the electrode, electrode reel, welding head, nozzle or semiautomatic welding gun are also electrically "hot".
- 3.d. Always be sure the work cable makes a good electrical connection with the metal being welded. The connection should be as close as possible to the area being welded.
- 3.e. Ground the work or metal to be welded to a good electrical (earth) ground.
- 3.f. Maintain the electrode holder, work clamp, welding cable and welding machine in good, safe operating condition. Replace damaged insulation.
- 3.g. Never dip the electrode in water for cooling.
- 3.h. Never simultaneously touch electrically "hot" parts of electrode holders connected to two welders because voltage between the two can be the total of the open circuit voltage of both welders.
- 3.i. When working above floor level, use a safety belt to protect yourself from a fall should you get a shock.
- 3.j. Also see Items 6.c. and 8.



ARC RAYS can burn.

- 4.a. Use a shield with the proper filter and cover plates to protect your eyes from sparks and the rays of the arc when welding or observing open arc welding. Headshield and filter lens should conform to ANSI Z87.1 standards.
- 4.b. Use suitable clothing made from durable flame-resistant material to protect your skin and that of your helpers from the arc rays.
- 4.c. Protect other nearby personnel with suitable, non-flammable screening and/or warn them not to watch the arc nor expose themselves to the arc rays or to hot spatter or metal.



FUMES AND GASES can be dangerous.

- 5.a. Welding may produce fumes and gases hazardous to health. Avoid breathing these fumes and gases. When welding, keep your head out of the fume. Use enough ventilation and/or exhaust at the arc to keep fumes and gases away from the breathing zone. **When welding with electrodes which require special ventilation such as stainless or hard facing (see instructions on container or MSDS) or on lead or cadmium plated steel and other metals or coatings which produce highly toxic fumes, keep exposure as low as possible and below Threshold Limit Values (TLV) using local exhaust or mechanical ventilation. In confined spaces or in some circumstances, outdoors, a respirator may be required. Additional precautions are also required when welding on galvanized steel.**
- 5.b. Do not weld in locations near chlorinated hydrocarbon vapors coming from degreasing, cleaning or spraying operations. The heat and rays of the arc can react with solvent vapors to form phosgene, a highly toxic gas, and other irritating products.
- 5.c. Shielding gases used for arc welding can displace air and cause injury or death. Always use enough ventilation, especially in confined areas, to insure breathing air is safe.
- 5.d. Read and understand the manufacturer's instructions for this equipment and the consumables to be used, including the material safety data sheet (MSDS) and follow your employer's safety practices. MSDS forms are available from your welding distributor or from the manufacturer.
- 5.e. Also see item 1.b.

Mar '95

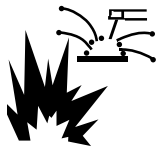

WELDING SPARKS can cause fire or explosion.

- 6.a. Remove fire hazards from the welding area. If this is not possible, cover them to prevent the welding sparks from starting a fire. Remember that welding sparks and hot materials from welding can easily go through small cracks and openings to adjacent areas. Avoid welding near hydraulic lines. Have a fire extinguisher readily available.
- 6.b. Where compressed gases are to be used at the job site, special precautions should be used to prevent hazardous situations. Refer to "Safety in Welding and Cutting" (ANSI Standard Z49.1) and the operating information for the equipment being used.
- 6.c. When not welding, make certain no part of the electrode circuit is touching the work or ground. Accidental contact can cause overheating and create a fire hazard.
- 6.d. Do not heat, cut or weld tanks, drums or containers until the proper steps have been taken to insure that such procedures will not cause flammable or toxic vapors from substances inside. They can cause an explosion even though they have been "cleaned". For information, purchase "Recommended Safe Practices for the Preparation for Welding and Cutting of Containers and Piping That Have Held Hazardous Substances", AWS F4.1 from the American Welding Society (see address above 1.a. [Safety]).
- 6.e. Vent hollow castings or containers before heating, cutting or welding. They may explode.
- 6.f. Sparks and spatter are thrown from the welding arc. Wear oil free protective garments such as leather gloves, heavy shirt, cuffless trousers, high shoes and a cap over your hair. Wear ear plugs when welding out-of-position or in confined places. Always wear safety glasses with side shields when in a welding area.
- 6.g. Connect the work cable to the work as close to the welding area as practical. Work cables connected to the building framework or other locations away from the welding area increase the possibility of the welding current passing through lifting chains, crane cables or other alternate circuits. This can create fire hazards or overheat lifting chains or cables until they fail.
- 6.h. Also see item 1.c.

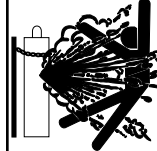

CYLINDER may explode if damaged.

- 7.a. Use only compressed gas cylinders containing the correct shielding gas for the process used and properly operating regulators designed for the gas and pressure used. All hoses, fittings, etc. should be suitable for the application and maintained in good condition.
- 7.b. Always keep cylinders in an upright position securely chained to an undercarriage or fixed support.
- 7.c. Cylinders should be located:
 - Away from areas where they may be struck or subjected to physical damage.
 - A safe distance from arc welding or cutting operations and any other source of heat, sparks, or flame.
- 7.d. Never allow the electrode, electrode holder or any other electrically "hot" parts to touch a cylinder.
- 7.e. Keep your head and face away from the cylinder valve outlet when opening the cylinder valve.
- 7.f. Valve protection caps should always be in place and hand tight except when the cylinder is in use or connected for use.
- 7.g. Read and follow the instructions on compressed gas cylinders, associated equipment, and CGA publication P-1, "Precautions for Safe Handling of Compressed Gases in Cylinders," available from the Compressed Gas Association 1235 Jefferson Davis Highway, Arlington, VA 22202.



FOR ELECTRICALLY powered equipment.

- 8.a. Turn off input power using the disconnect switch at the fuse box before working on the equipment.
- 8.b. Install equipment in accordance with the U.S. National Electrical Code, all local codes and the manufacturer's recommendations.
- 8.c. Ground the equipment in accordance with the U.S. National Electrical Code and the manufacturer's recommendations.

Mar '95

<http://www.rapidwelding.com>

CUSTOMER ASSISTANCE POLICY

The business of The Lincoln Electric Company is manufacturing and selling high quality welding equipment, consumables, and cutting equipment. Our challenge is to meet the needs of our customers and to exceed their expectations. On occasion, purchasers may ask Lincoln Electric for advice or information about their use of our products. We respond to our customers based on the best information in our possession at that time. Lincoln Electric is not in a position to warrant or guarantee such advice, and assumes no liability, with respect to such information or advice. We expressly disclaim any warranty of any kind, including any warranty of fitness for any customer's particular purpose, with respect to such information or advice. As a matter of practical consideration, we also cannot assume any responsibility for updating or correcting any such information or advice once it has been given, nor does the provision of information or advice create, expand or alter any warranty with respect to the sale of our products.

Lincoln Electric is a responsive manufacturer, but the selection and use of specific products sold by Lincoln Electric is solely within the control of, and remains the sole responsibility of the customer. Many variables beyond the control of Lincoln Electric affect the results obtained in applying these types of fabrication methods and service requirements.

Subject to Change – This information is accurate to the best of our knowledge at the time of printing. Please refer to www.lincolnelectric.com for any updated information.

LINCOLN NORTH AMERICA

DISTRICT SALES OFFICES

U.S.A.

ALABAMA

BIRMINGHAM 35124-1156
(205) 988-8232
MOBILE 36582-5209
(251) 443-6524

ALASKA

Contact VANCOUVER, WA
(360) 693-4712

ARIZONA

PHOENIX 85260-1745
(480) 348-2004

ARKANSAS

LITTLE ROCK 72032-4371
(501) 764-0480

CALIFORNIA

FRESNO 93722-3949
(559) 276-0110
LOS ANGELES 90670-2936
(562) 906-7700
SAN DIEGO 92065-4165
(760) 787-1970
NORTHERN CALIFORNIA
95762-5706
(916) 939-8788

COLORADO

DENVER 80112-5115
(303) 792-2418

CONNECTICUT

NORTH HAVEN 06238-1090
(860) 742-8887

FLORIDA

JACKSONVILLE 32216-4634
(904) 642-3177
MIAMI 33178-1175
(305) 888-3203
ORLANDO 32714-1974
(407) 788-8557
TAMPA 33594
(813) 477-5817

GEORGIA

ATLANTA 30076-4914
(770) 475-0955
SAVANNAH 31324-5180
(912) 727-4286

HAWAII

Contact LOS ANGELES, CA
(562) 906-7700

IDAHO

BOISE 83616-6646
(208) 938-2302

ILLINOIS

CHICAGO 60527-5629
(630) 920-1500
PEORIA 60527-5629
(630) 920-1500

INDIANA

EVANSVILLE 47630
(812) 454-3428
FT. WAYNE 46825-5547
(260) 484-4422
SOUTH BEND 46561-9160
(219) 674-5523
INDIANAPOLIS 46250-5536
(317) 845-8445

IOWA

CEDAR RAPIDS 52402-3160
(319) 362-6804
DAVENPORT 52806-1344
(563) 386-6522
DES MOINES 50265-6218
(515) 963-1778

KANSAS

KANSAS CITY 66214-1625
(913) 894-0888
WICHITA 67037-9614
(316) 788-7367

KENTUCKY

LOUISVILLE 47112-7025
(502) 727-7335

LOUISIANA

BATON ROUGE 70808-3150
(225) 922-5151
LAFAYETTE 70507-3126
(337) 886-1090
SHREVEPORT 75692-9313
(318) 518-4099

MARYLAND

BALTIMORE 21050-3067
(443) 831-0416

MASSACHUSETTS

BOSTON 01701-7726
(608) 788-9353

MICHIGAN

DETROIT 48034-4005
(248) 353-9680
FLINT 48439-8728
(810) 695-2627
GRAND RAPIDS 49512-3924
(616) 942-8780

MINNESOTA

MINNEAPOLIS 55447-4743
(763) 551-1990

MISSISSIPPI

JACKSON 39212-9635
(601) 372-7679

MISSOURI

KANSAS CITY (KS) 66214-1625
(913) 894-0888
ST. LOUIS 63045
(314) 291-5877
SPRINGFIELD 65804
(417) 841-2779

MONTANA

Contact VANCOUVER, WA
(360) 693-4712

NEBRASKA

OMAHA 68046-2826
(402) 339-1809

NEW JERSEY

EDISON 08837-3939
(732) 225-2000

NEW MEXICO

ALBUQUERQUE 87008
(505) 890-6347

NEW YORK

ALBANY 12304-4320
(518) 469-8222
BUFFALO 14075-2520
(716) 646-8414
NEW YORK CITY
(888) 269-6755
SYRACUSE 13057-9313
(315) 432-0281

NORTH CAROLINA

CHARLOTTE 28273-6200
(704) 588-3251
RALEIGH 27604-8456
(919) 303-1972

OHIO

AKRON 44236-4680
(330) 342-8009
CINCINNATI 45242-3706
(513) 554-4440
CLEVELAND 44117-2525
(216) 383-2662
COLUMBUS 43221-4073
(614) 488-7913
DAYTON 45458
(937) 885-6964
TOLEDO 43528-9483
(419) 867-7284

OKLAHOMA

OKLAHOMA CITY 73139-2432
(405) 616-1751
TULSA 74146-1622
(918) 622-9353

PENNSYLVANIA

PHILADELPHIA 19008-4310
(610) 543-9462
PITTSBURGH 15001-4800
(724) 857-2750
HARRISBURG
17104-1422
(717) 213-9163

SOUTH CAROLINA

GREENVILLE 29681-4724
(864) 967-4157
COLUMBIA 29209
(803) 783-2851

SOUTH DAKOTA

SIoux FALLS 57108-2609
(605) 339-6522

TENNESSEE

KNOXVILLE 37922-1736
(423) 612-1204
MEMPHIS 38119
(901) 683-6260
NASHVILLE 37228-1708
(615) 291-9926
TRI-CITIES 37659-5693
(423) 612-1204

TEXAS

DALLAS 76051-7602
(817) 329-9353
HOUSTON 77060-3143
(281) 847-9444
SAN ANTONIO 78258-4009
(210) 393-9337

UTAH

MIDVALE 84047-3759
(801) 233-9353

VIRGINIA

LEESBURG, VA 20175-3911
Washington, D.C.
(703) 904-7735
DANVILLE
(434) 489-3222
HAMPTON ROADS 23693-4171
(757) 870-5508

WASHINGTON

VANCOUVER 98661-8023
(360) 693-4712
SPOKANE 99005-9637
(509) 468-2770

WASHINGTON DC

LEESBURG, VA 20175-3911
(703) 904-7735

WEST VIRGINIA

CHARLESTON 25526-8864
(304) 757-9862

WISCONSIN

GREEN BAY 54302-1829
(920) 435-1012
MILWAUKEE 53186-0403
(262) 650-9364

CANADA

ALBERTA

CALGARY
(403) 253-9600/(877) 600-WELD
EDMONTON
(780) 436-7385
WINNIPEG
(204) 488-6398

BRITISH COLUMBIA

VANCOUVER
(604) 945-7524

MARITIMES

NEW BRUNSWICK
(506) 849-4474

MANITOBA

WINNIPEG
(204) 488-6398

ONTARIO

MISSISSAUGA
(905) 565-5600
TORONTO
(416) 421-2600/(800) 268-0812

QUEBEC

MONTREAL
(450) 654-3121

LINCOLN INTERNATIONAL HEADQUARTERS

LATIN AMERICA

Miami, Florida U.S.A.
Phone: (305) 888-3203

EUROPE

Barcelona, Spain
Phone: 34 91 816 4266

RUSSIA, AFRICA & MIDDLE EAST

Cleveland, Ohio U.S.A.
Phone: (216) 481-8100

ASIA PACIFIC

Singapore
Phone: 65 6773 6689
Australia
Phone: 61 2 9772 7222

HARRIS CALORIFIC DIVISION

2345 Murphy Blvd., Gainesville, Georgia 30504 U.S.A.
Phone: 1-800-241-0804 • Fax: (770) 535-0544 • Web Site: www.harriscal.com

LINCOLN
ELECTRIC

THE WELDING EXPERTSSM

THE LINCOLN ELECTRIC COMPANY

22801 St. Clair Ave.
Cleveland, Ohio 44117-1199

TEL: 216.481.8100 • FAX: 216.486.1751

lincolnelectric.com

Aluminum Welding Guide
C8.100 9/06